



Applied Thermal Control Ltd  
39 Hayhill Industrial Estate  
Barrow-upon-Soar, Loughborough  
LE12 8LD, United Kingdom  
+44 (0) 1530 839 998  
Service@thermalexchange.co.uk  
Support@app-therm.com

# Installation, Operation & Service Manual

## MPC3 / MPC10 / MPC18 / MPD3

### DOCUMENT DETAILS

Date	28/OCT/2020	Author(s)	MJH	Page	1 / 5	Revision	4
------	-------------	-----------	-----	------	-------	----------	---





Applied Thermal Control Ltd  
 39 Hayhill Industrial Estate  
 Barrow-upon-Soar, Loughborough  
 LE12 8LD, United Kingdom  
 +44 (0) 1530 839 998  
 Service@thermalexchange.co.uk  
 Support@app-therm.com

# Installation, Operation & Service Manual

# MPC3 / MPC10 / MPC18 / MPD3

## DOCUMENT DETAILS

Date	28/OCT/2020	Author(s)	MJH	Page	2 / 5	Revision	4
------	-------------	-----------	-----	------	-------	----------	---

## CHANGE LOG

Date	Revision	Page ref	Change
5/DEC/2019	1	-	First release.
27/JAN/2020	2	Product Specification	Pump curve graph edited.
		Annex L	Inclusion of RS485 ModBUS Protocol guide
28/AUG/2020	3	Annex C	Correction to standard fittings supply
28/OCT/2020	4	Product Specification	Clarification of QR size



Applied Thermal Control Ltd  
 39 Hayhill Industrial Estate  
 Barrow-upon-Soar, Loughborough  
 LE12 8LD, United Kingdom  
 +44 (0) 1530 839 998  
 Service@thermalexchange.co.uk  
 Support@app-therm.com

# Installation, Operation & Service Manual

## MPC3 / MPC10 / MPC18 / MPD3

### DOCUMENT DETAILS

Date	28/OCT/2020	Author(s)	MJH	Page	3 / 5	Revision	4
------	-------------	-----------	-----	------	-------	----------	---

### PRODUCT SPECIFICATIONS

Attribute	Unit	Value
Dimensions (W*D*H)	mm	180*435*380
	inch	7.1*17.1*15
Weight	kg	20
	lbs.	44.1
Heat transfer fluid volume	mL	650
	USGal	0.172
Cooling capacity (T <sub>ambient</sub> +20°C / +68°F) (T <sub>setpoint</sub> +20°C / +68°F)	W	500
	BTU/h	1706
	RT	0.142
Temp. adjustment	±°C	0.1
Settable temp. range	°C	+4 to +35
Optional temp. range	°C	-10 to +65
Power supply requirement	VAC	100-240
	Hz	50/60
	A	1@240VAC 2@115VAC
Sound pressure level	dBa	35-64
Controller screen size	inch	4.3" diagonal
Auto-diagnostic functions	PID, compressor and fan percentage utilization. Fridge system high pressure value. Compressor error states. Export system log via USB.	
Fluid fittings (standard)	Pushfit 12mm	
Fluid fittings (option)	Valved QR 9.5mm (3/8")	
Low fluid level alarm	Visual, 3 level	
Controller screen	Resistive type, glove-friendly, pen-friendly.	
Tool-less access	No	
Overtemperature protection	Hardware limited Software settable	
Compressor overload protection	Via PCB function	
Overcurrent protection	Fused, 2* T6.3A H250V	
Rated duty cycle	Continuous	
Compatible heat transfer fluids	DI water, propylene glycol mixes, Hexid A4 & A6	

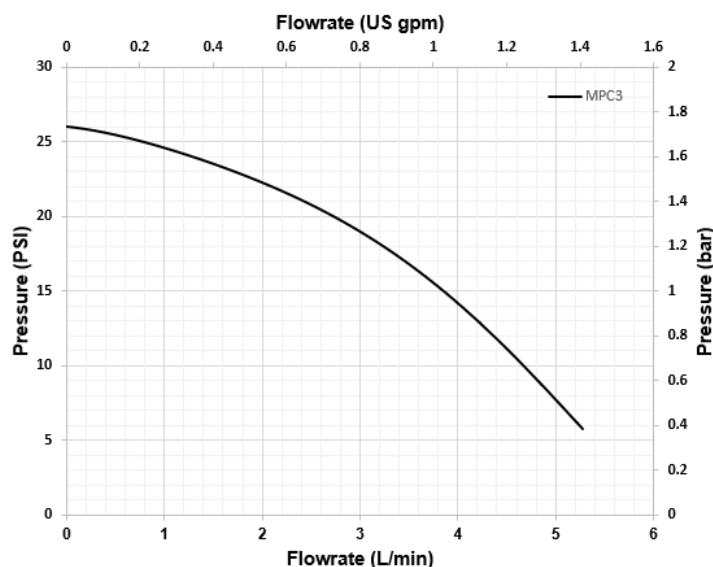



**Applied Thermal Control Ltd**  
 39 Hayhill Industrial Estate  
 Barrow-upon-Soar, Loughborough  
 LE12 8LD, United Kingdom  
 +44 (0) 1530 839 998  
 Service@thermalexchange.co.uk  
 Support@app-therm.com

# Installation, Operation & Service Manual

## MPC3 / MPC10 / MPC18 / MPD3

### DOCUMENT DETAILS

Date	28/OCT/2020	Author(s)	MJH	Page	4 / 5	Revision	4
------	-------------	-----------	-----	------	-------	----------	---

### SAFETY NOTICES

For your safety, we draw your attention to the following warning and caution marks throughout the manual; the safe operation of an ATC chiller always remains the responsibility of the operator. This equipment is intended to be used as a liquid temperature conditioning device – it requires no external pump, nor any further manipulation of temperature. If the equipment is used in a manner not specified by the manufacturer, the protection provided by the equipment may be impaired.



Caution; Failure to comply with a caution will invalidate product warranty and absolve ATC from any liability, howsoever caused, and could result in permanent damage to equipment.



Caution; Filling/topping up of the tank should only be undertaken with the unit switched off, to prevent back-filling of the fluid.



Caution; The high integrity refrigeration system contains no user-serviceable parts. Repair and service requires specialized knowledge and tools to be provided by ATC or its local agent. Any unauthorized tampering with the refrigeration system automatically invalidates warranty.



Warning; Very cold surfaces and gases, lower than -20°C (-40°F). Severe frostbite hazard.



Warning; Opening the refrigeration system may expose the operator to toxic and corrosive compounds (HFCs). Take protective measures including suitable eye protection.



Warning; Gases may exceed 15 barg (220psig) during operation.



Warning; Refrigerant is class A1. It does not support combustion but is oxygen depleting. Refrigerant charge in the Mini is 360g (12.7oz) of R134a.



Warning; Water and electricity are in close proximity. Always ensure the unit is isolated before service. The Mini is protected from overcurrent by mains fusing. Never bypass this component.



Warning; Failure to comply with a 'warning' may result in personal injury or death. ATC does not accept any liability for injury caused through use of this equipment.



Warning; After switching off, the fan blades slow to a stop. Do not open until the fan has stopped rotating.



Affixed to the chiller's fan, this symbol printed on yellow background advises of the possible damage to fingers or other extremities from rotating fan blades. Allow blades to stop before service begins.



Applied Thermal Control Ltd  
39 Hayhill Industrial Estate  
Barrow-upon-Soar, Loughborough  
LE12 8LD, United Kingdom  
+44 (0) 1530 839 998  
Service@thermalexchange.co.uk  
Support@app-therm.com

# Installation, Operation & Service Manual

## MPC3 / MPC10 / MPC18 / MPD3

### DOCUMENT DETAILS

Date	28/OCT/2020	Author(s)	MJH	Page	5 / 5	Revision	4
------	-------------	-----------	-----	------	-------	----------	---

### INCLUDED ANNEXES

Specific technical product information is provided in the following series of annexes.

- Annex A-1 191122 Unpacking - Weighing over 18kg
- Annex B-1 191122 Mini & EcoMini site and environmental requirements
- Annex C-1 200901 Installation - Mini & EcoMini
- Annex D-1 191122 Mini fill procedure
- Annex E-1 200707 XTD controller XTD043RB-K620G&F (Mini at SW v39.4)
- Annex F-1 191129 Pres & flow in Mini with centrif pump
- Annex G-1 191129 Mini, generic initial troubleshooting
- Annex H-1 191121 Generic periodic maintenance for end users
- Annex I-1 191129 Generic maintenance for technicians
- Annex J-1 200901 EcoMini & Mini series EU DoC
- Annex J-5 200706 Conflict Minerals compliance statement
- Annex J-7 200715 REACH compliance statement
- Annex J-8 200827 POPs compliance statement
- Annex K-1 200623 Standard warranty terms of ATC
- Annex L-11M 190503 SA00011M RS485 ModBUS RTU for Mini
- Annex M-1 200828 Recommended spares, Mini & EcoMini
- Annex R-1 170621 SDS for refrigerant HFC-R134a
- Annex R-3 200203 SDS Hexid A4 v6.3



Applied Thermal Control Ltd  
39 Hayhill Industrial Estate  
Barrow-upon-Soar, Loughborough  
LE12 8LD, United Kingdom  
+44 (0) 1530 839 998  
Service@thermalexchange.co.uk  
Support@app-therm.com

## Operating Manual; Unpacking

# Annex A-1

### DOCUMENT DETAILS

Date	22/NOV/2019	Author(s)	MJH / LW	Page	1 / 1	Revision	1
------	-------------	-----------	----------	------	-------	----------	---

### UNPACKING

Please check that both the packaging and the unit are undamaged. If there is any doubt, it is vital that you inform both ATC and the carrier. There are no hidden shipping bolts or other fixings. You should inspect the packaging for signs of transit damage before signing for the unit, and if possible, unpack the unit before signing. Once you have signed for the goods, ATC cannot be held responsible for any transit damage subsequently found.

As the unit is >18kg, ATC must recommend that 2 persons are used to lift by hand, or a crane. Remove the unit from its original packaging and ensure that there is no packaging left around the cooling ducts. There is no internal product packaging that requires the chiller to be opened.

**Please retain all packaging in the unlikely event that the chiller needs to be returned to our local representatives.**



# Annex B-1

## DOCUMENT DETAILS

Date November 2019

Compiled by MJH

Revision 1

## SITE & ENVIRONMENTAL REQUIREMENTS

- a) **Hard, level surface** – Feet on the Mini provide a degree of friction on most work surfaces to prevent sliding. A level surface is important for ensuring proper filling and allowing air to escape.
- b) **Clean, dust-free environment** – air-cooled chillers move large volumes of air, and large amounts of air-borne contamination will result in fouling of the condenser, reducing the capacity of the unit and in extreme cases causing a system shut-down.
- c) **Non-condensing ambient** – +5°C to +40°C (+39°F to +104°F). Capacity is lost above +30°C (+86°F).
- d) **Humidity** - 80% for ambient temperatures up to +31°C (+88°F), decreasing linearly to 50% relative humidity at +40°C (+104°F) ambient temperature.
- e) **Electrical supply** – the Mini comes with a Switch Mode Power Supply capable of accepting;
  - a. Voltage fluctuations of  $\pm 10\%$  of the nominal voltage.
  - b. Frequency of 47Hz to 63Hz inclusive.
  - c. Maximum current draw of 5.8A@100VAC; mains fusing is rated 6.3A, accessible from rear.
    - i. See product rating label for fuse specification.
    - ii. Two modes of supply are acceptable; **L1 / N / E** or **L1 / L2 / E**
    - iii. The inlet module itself is rated 10A 250V.
    - iv. Protective earth must be provided by user at IEC type C14 appliance inlet.
- f) **Clearance** – left and right of the unit require clearance of  $\geq 300\text{mm}$  ( $\geq 11.8''$ ). Care must be taken to prevent the recirculation of rejected hot air, back into the condenser. This will result in damage if repeated. Ensure there is sufficient room at the rear of the product to remove the power cable without obstruction.
- g) **Plumbing** – tubing, piping or hose must be clean and compatible with the fluid to be used. The chiller is compatible with deionized water and water-glycol mixtures such as Hexid fluid.
- h) **Indoor use only** – altitude up to 2000m.
- i) **Installation category** – transient overvoltage category II; Pollution degree 2. Temporary overvoltages occurring on mains supply are acceptable within limits defined in the aforementioned categories.



Caution; Always use ATC recommended fluids in your chiller – many other anti-freeze mixtures have the potential to corrode your application and to damage seals in the chiller.



**DOCUMENT DETAILS**

Date	28/AUG/2020	Author(s)	MJH/AMI	Page	1 / 1	Revision	1
------	-------------	-----------	---------	------	-------	----------	---

**INSTALLATION**

Having ensured that your installation meets all site requirements, it is best practice that the fluid lines between your application and the chiller have the following characteristics;

- a) **Short in length** – this reduces friction-based pressure drop and addition ambient heat load
- b) **Large diameter bore** – at least 8mm (5/16”).
- c) **Free from 90° bends** – to limit the effects of water hammer. If this cannot be avoided, sharp changes of direction should be minimized so far as possible. Doing this correctly can yield higher pump performance and extend time between maintenance intervals. It can also reduce electrical energy consumption.
- d) **Clean** – If your installation is to existing pipe work, it is good practice to flush the system with either a commercially available central heating cleaner or 5% acetic acid solution. The system should be flushed clean with tap water to remove all traces of cleaner prior to filling the system. Failing this, it is recommended to use a domestic bleach in solution with tap water, diluted to the point where the bleach can longer be smelled by a human.
- e) **Opaque, ideally black** – to inhibit light passing through the tube and algae building up. Alternatively, solid ABS or copper pipe can be used.



Caution; Never use transparent tubing. UV light will pass through, prompting growth of organic contamination.

The Mini and EcoMini are supplied with quick release fittings by default either of the CPC or push fit variety. The former of these have built-in valves to prevent loss of fluid when disconnecting but other types may not. The mating halves of these connectors are available in a variety of fitting types, i.e. barb, quick release, compression. Sealing guidelines should be followed for each specific type of fitting.

Ensure that the system is correctly connected, with the chiller outlet connected to the application inlet, and application outlet connected to chiller inlet. Check all joints are tight and leak free.

Where this product is incorporated into other equipment, it is the responsibility of the assembler to ensure safety.



Caution; Do not replace detachable mains cords with inadequately rated cords. Contact ATC for appropriately rated products.

**Preventing Backfilling** – In situations where the chiller is situated physically lower than the application being cooled it is possible that upon stopping the pump the effect of gravity on the process fluid can cause it to leave the application.

In this scenario, the fluid falls back into the chiller, placing pressure from the water column upon all chiller water circuit faces. The weakest point in terms of sealing is the tank lid, and this is typically where fluid will escape the unit, overflowing into the chiller.

For this reason, it's always a good idea to situate the chiller higher than the application so that when the pump is turned off, the tank is the highest point in the system and the liquid will flood into the application which should be sealed.

If this is not possible, a non-return solenoid valve kit can be installed as an optional standard assembly. Please raise any questions with the sales team on sales@app-therm.com.





### DOCUMENT DETAILS

Date November 2019

Compiled by MJH

Revision 1

### FILLING PROCEDURE

The Mini chiller has a different fill procedure to ATC's other products. Please read the entire passage before starting and familiarize yourself with the process.

- a) **Connect the chiller to the electrical supply and switch on at the rear rocker switch.**
- The controller should begin to load and leave you on the splash screen with ATC logo as pictured below. Your serial number and software version may differ.



- b) **Check all application valves are open, including solenoid valves and variable position valves.**
- The chiller will require an open water circuit to pump into.
  - Any obstructions can increase the time, or entirely prevent the bleeding of air from the system.
- c) **Remove the cap from the tank lid on the top of the chiller.**
- Fill the tank to leave 10-20mm (0.4-0.8") of air between water line and where the lid seals.
- d) **Turn your attention to the screen on the front of the chiller. Above the settings 'gear' icon, you will see a pump icon.**
- Holding this icon will run the pump, and it will ignore any interlock provided by the level switches.
  - Hold the button until the water line drops to just above the outlet port, then release.



Caution; Do not run the pump dry. Do not deadhead the pump.

- e) **Repeat steps c) i) and d) until the level no longer drops when the pump is run.**
- f) **Start the chiller by holding the green process start button in the top right.**
- Leave the cap off the tank for >30mins to allow air to escape.
  - Whilst running, the tank illustration on the user interface ought to stay green and full.

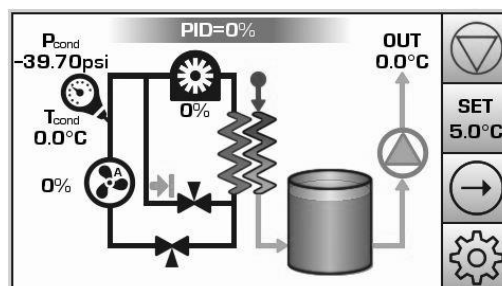

- g) **Check the application and tubing for signs of leaks whilst the chiller is running.**
- Replace the tank lid when satisfied the system is full and bled of air.

### DOCUMENT DETAILS

Date 5/DEC/2019 Author(s) MJH Page 1 / 9 Revision 1

### XTD043RB-K620G / XTD043RB-K620F (SOFTWARE VERSION 39.4, MINI PROJECT)



#### Splash Screen

Upon first powering on, the chiller will arrive at this page after a software loading sequence is complete.

1. Process-start will start fridge and water circuit.
2. Pump priming button runs pump without process starting.
3. Access to settings menu.
4. Service pack refers to software version installed.
5. Serial number is added by ATC during production.

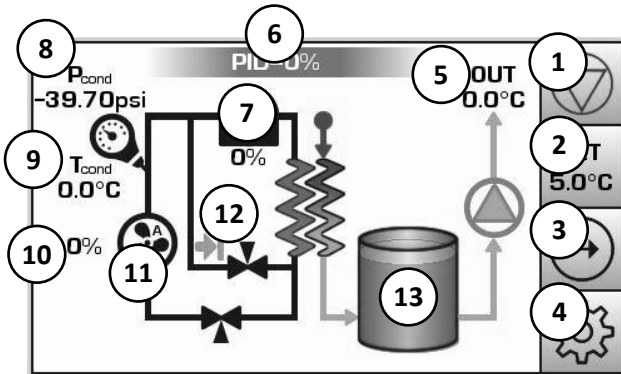

#### Process View

1. Process stop.
2. Set outlet temperature.
3. Carousel scroll.
4. Settings menu.
5. Actual outlet temperature.
6. System overall utilization.
7. Compressor utilization.
8. High side fridge pressure.
9. Condensing temperature.
10. Fan speed utilization.
11. Fan speed mode.
12. Bypass valve status.
13. Tank level status.

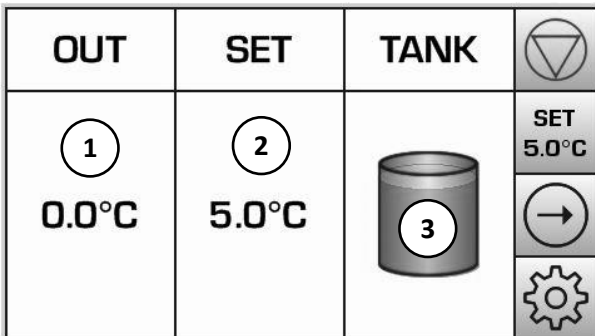

#### Simple View

1. Actual outlet temperature.
2. Setpoint temperature.
3. Tank level status.

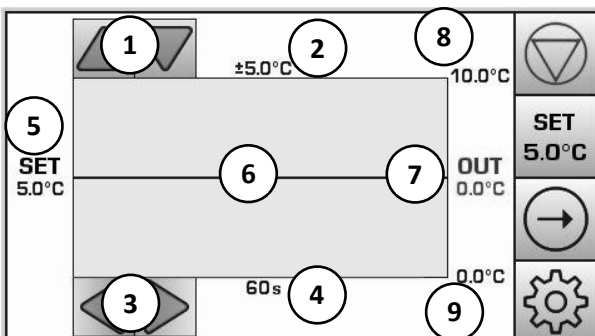

#### Tolerance Plot

1. Adjusts the plotting resolution to aid visibility.
2. Relative to point 1, the current set resolution.
3. Adjusts the length of time over which data is plotted.
4. Relative to point 3, the current timeframe.
5. Current setpoint, a fixed horizontal line, i.e. a target.
6. A red line will be plot continuously about the black set line.
7. The actual temperature being plotted.
8. Based on the tolerance set at point 2, the upper tolerance.
9. Based on the tolerance set at point 2, the lower tolerance.

## DOCUMENT DETAILS

Date 5/DEC/2019 Author(s) MJH Page 2 / 9 Revision 1

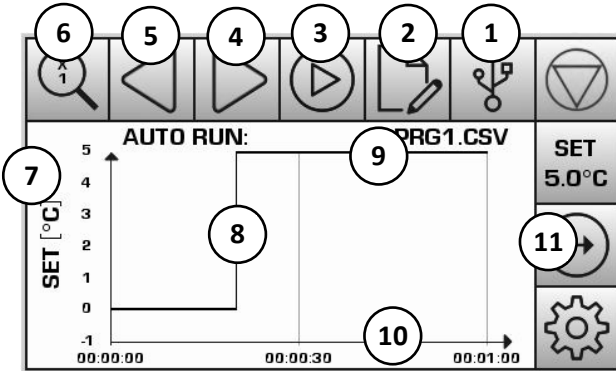

### Program Mode

1. USB program loading and software management menu.
2. Create new or load existing program.
3. Start loaded program.
4. Scroll right through scheduled setpoints.
5. Scroll left through scheduled setpoints.
6. Adjusts the scale of the X axis to aid visibility of program.
7. Y axis shows the range of setpoint values in program.
8. Vertical line shows programmed change to setpoint temp.
9. Name of loaded program.
10. X axis shows time scale of entire program.
11. Move through carousel onto 'Engineering View'.

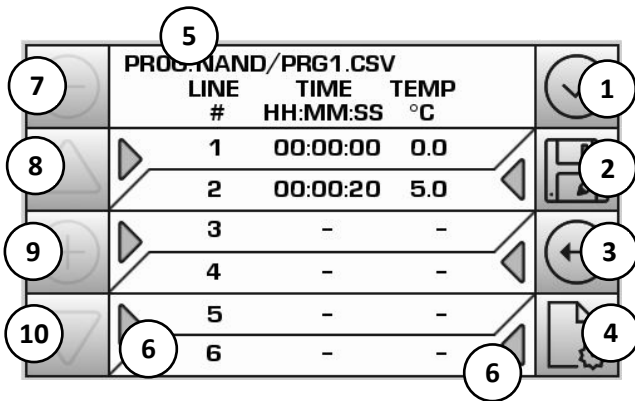

LINE #	TIME	TEMP °C
1	00:00:00	0.0
2	00:00:20	5.0
3	-	-
4	-	-
5	-	-
6	-	-

### Manage Programs (generate, load from NAND and modify)

Menu accessible via button '2' under 'Program Mode'.

1. Accept changes and revert to Program Mode above.
2. Save changes to local NAND memory.
3. Back button reverts to Program Mode above.
4. Takes you to 'Existing Programs' menu.
5. Name of loaded program in the course of being edited.
6. When line added, tapping the arrows first selects the line, then allows editing of line time and setpoint temperature.
7. Delete the selected line.
8. Move up to earlier lines where program lines exceed 6.
9. Add a new line. Lines automatically move up if deleted.
10. Move down to later lines where program lines exceed 6.

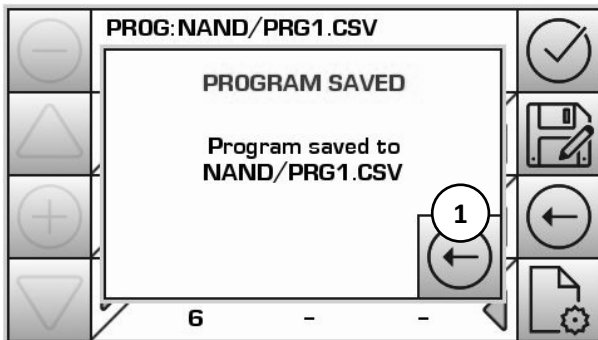

### Save screen

Appears when button '2' from 'Manage Programs' is used.

1. Back out to 'Manage Program' menu.

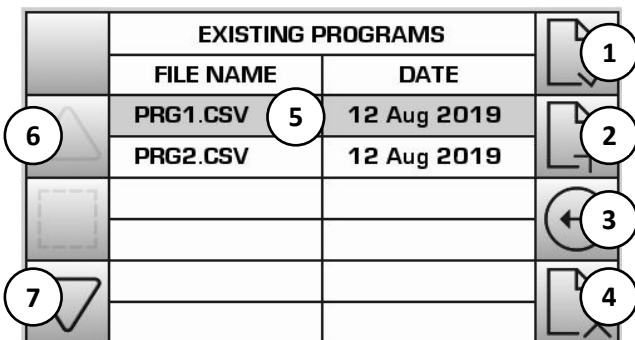

FILE NAME	DATE
PRG1.CSV	12 Aug 2019
PRG2.CSV	12 Aug 2019

### Existing Programs in NAND Memory

Menu accessible via button '4' under 'Manage Programs'.

1. Load highlighted program (reverts to 'Manage Programs').
2. Copy highlighted program to new line.
3. Return to 'Manage Programs'.
4. Delete highlighted program (warning; no confirmation!).
5. Selected program is highlighted grey.
6. When  $\geq 2$  programs are in the list, use up arrow to select.
7. When  $\geq 2$  programs are in the list, use down arrow to select.

**DOCUMENT DETAILS**

Date 5/DEC/2019 Author(s) MJH Page 3 / 9 Revision 1

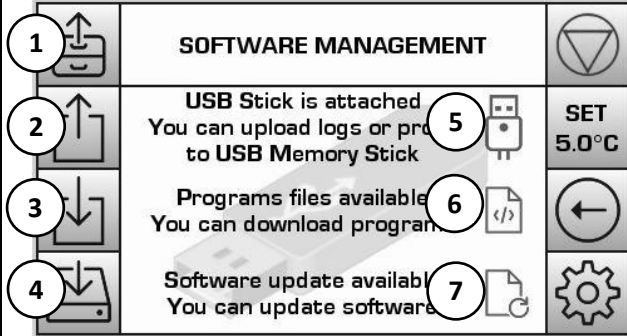

**Software Management (incl. logs and programs)**

1. Error log upload to USB device. Sends a CSV file.
2. Upload programs created on MS Excel.  
*To generate a CSV template, upload a 'dummy' program.*
3. Download programs created on-screen into CSV file.
4. Install software update (see *Reset Options* below).
5. A USB stick is available both uploading and downloading.
6. CSV programs available to download into NAND memory.
7. Software update recognized on USB device.

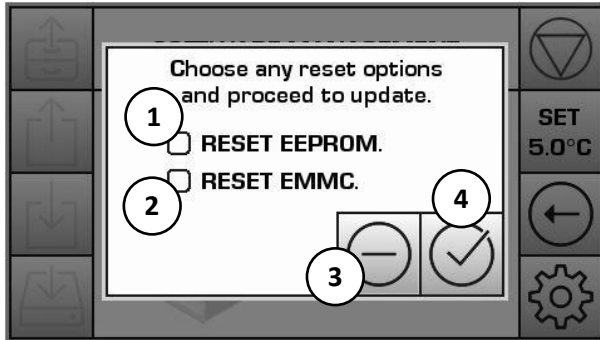

**Reset Options**

*Menu accessible via button '4' under 'Software Management'.*

1. EEPROM resets all machine settings back to default.  
*Some software updates will require this to be ticked.*
2. EMMC reset deletes all internal memory and log files.
3. Cancel software update.
4. Start update process.

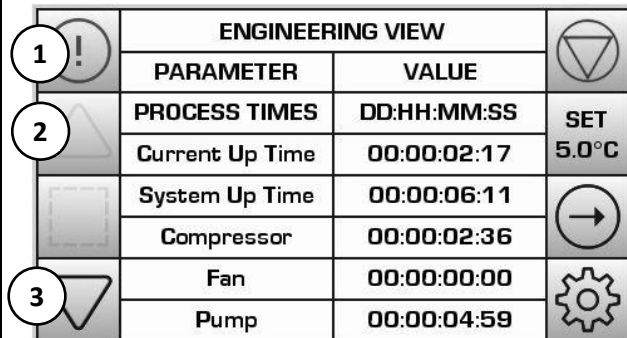

**Engineering View**

1. When illuminated red, tap to move to error view (below).
2. Scroll up through available parameters.
3. Scroll down through available parameters.

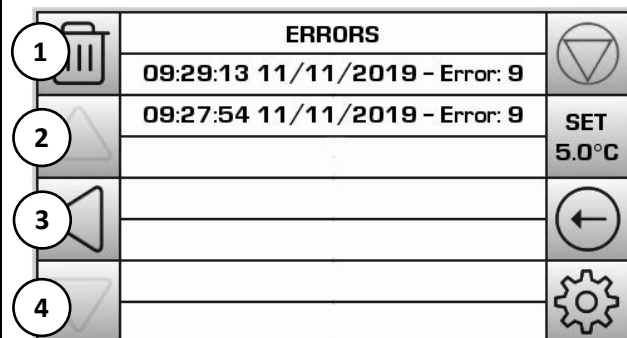

**Error View**

1. Clear error lists.
2. Scroll up through error list.
3. Return to 'Engineering View'.
4. Scroll down through error list.

**Error Codes**

1. Comp. overload/locking.
2. Comp. disconnected.
3. Comp. overcurrent.
4. Comp. abnormal VDC.
5. Comp. PCB overheat.
6. PV PT100 disconnected.
7. Modbus data error.
8. Temp. high level limit.
9. Fluid tank empty.

**DOCUMENT DETAILS**

Date 5/DEC/2019 Author(s) MJH Page 4 / 9 Revision 1

MAINTENANCE DUE			
	Check Fluid Level	18/09/2018	! SET 5.0°C
	Fluid Change	01/10/2018	! →
	Clean Condensor	12/12/2020	✓ ⚙️

**Maintenance Prompt View**

1. Move up the parameter list.
2. Move down the parameter list.
3. Date is editable, tap to adjust next check date. When date is reached, text becomes red.
4. Exclamation mark is shown for overdue. Tap to confirm check made.
5. Tick mark is shown by black text for maintenance not due.

P <sub>cond</sub> -39.70psi	T <sub>cond</sub> 0.0°C	0%	OUT 0.0°C	SET 5.0°C
PASSCODE			↑	↓
1	2	3	DEL	⚙️
4	5	6	.	
7	8	9	:	
✕	0	-	✓	

**Passcode Entry**

1. Pressing the settings gear icon shows the passcode screen. Enter 4159 to enter factory settings. Enter 1234 to enter user settings.
2. Passcode appears in box above keyboard.
3. Select to enter passcode.

FACTORY SETTINGS				
	PARAM./VALUE	PARAM./VALUE		
	Machine Info	Units of Measure	SET 5.0°C	
	Menu	Menu		
	Maintenance	Limits / Alarms		
	Menu	Menu		
	Modbus	-		
	Menu	-		

**Factory Settings (1)**

- Screen available after successfully entering the passcode.
1. Down arrow scrolls through factory settings pages.
  2. Pressing the settings icon again takes you to user settings. User settings are a cut-back version of factory settings.
  3. Return to main carousel.
  4. Serial number, commissioning date, default power on, etc.
  5. Temperature and pressure display units, etc.
  6. Edit the text parameters of various maintenance prompts.
  7. Edit temperature and pressure limits before error log.
  8. Where capable, modify MODBUS settings.





FACTORY SETTINGS				
	PARAM./VALUE	PARAM./VALUE		
	User Settings PIN	-	SET 5.0°C	
	1234	-		
	User Standby PIN	-		
	4321	-		
	-	-		
	-	-		

**Factory Settings (2)**

- Scroll down from 'Factory Settings' (1) Further to 'Passcode Entry' above;
1. To access higher level settings, the user settings PIN can be edited while access has been gained to 'Factory Settings'.
  2. Where standby mode is enabled, this PIN appears to prevent the user from starting process without PIN entry first.

**DOCUMENT DETAILS**





Date 5/DEC/2019 Author(s) MJH Page 5 / 9 Revision 1

FACTORY SETTINGS			
	PARAM./VALUE	PARAM./VALUE	
	1 Compr. Settings Menu	2 Fan Settings Menu	SET 5.0°C
	3 Calibration Menu	4 Set Points Menu	
	5 Inputs Menu	6 Outputs Menu	

**Factory Settings (3)**

Scroll down from 'Factory Settings' (2)





1. Modify stop, minimum and maximum compressor speed.
2. Modify fan behavior, speed offset, min and max speed.
3. Modify temperature probe offset.
4. Modify default, minimum and maximum setpoint.
5. Modify input hardware termination positions.
6. Modify output hardware termination positions.

FACTORY SETTINGS			
	PARAM./VALUE	PARAM./VALUE	
	1 Display Settings Menu	2 Colour Theme Menu	SET 5.0°C
	3 Date/Time Menu	4 File Paths Menu	
	5 PID Cooling Menu	6 PID Heating Menu	

**Factory Settings (4)**

Scroll down from 'Factory Settings' (3)





1. Adjust brightness and screen orientation.
2. View and apply color themes.
3. Adjust real time clock settings.
4. Adjust naming conventions for log and scheduled programs.
5. Adjust controller (and system) behavior.
6. Adjust controller (and system) heating behavior.

FACTORY SETTINGS			
	PARAM./VALUE	PARAM./VALUE	
	1 Factory PIN 4159	2 Reset Password 2344159	SET 5.0°C
	3 Fact. Standby PIN 4159	4 Standby OFF/ON OFF	
	-	-	

**Factory Settings (5)**

Scroll down from 'Factory Settings' (4)

1. Set a new factory PIN for lower level settings access.
2. Reset password if EEPROM reset requests it.
3. Allows adjustment of factory standby PIN.
4. Enable standby mode, (password protected process start).





Machine Info			
	PARAM./VALUE	PARAM./VALUE	
	2 Serial No. 123	3 Display Ver. X	SET 5.0°C
	4 Commission Date 01/2019	5 Firmware Vers. 0	
	6 Power On Screen 3	7 Software Ver. S	

**Machine Information**

1. Return to 'Factory Settings' main menu.
2. Serial number is added here by factory electronically.
3. Display version, not editable.
4. Commissioning date (factory final test run date).
5. Firmware version, not editable.
6. Select a carousel screen to display upon process start.
7. Software version, not editable.
8. Exit back to main carousel.





## DOCUMENT DETAILS

Date 5/DEC/2019 Author(s) MJH Page 6 / 9 Revision 1

		Units of Measure		
		PARAM./VALUE	PARAM./VALUE	
		SET °C / K / °F 2 °C	Cond psi / bar 3 psi	SET 5.0°C
1		OUT °C / K / °F 4 °C	Cond °C / K / °F 5 °C	
		PID % / - 6 %	-	





### Units of Measure

1. Return to 'Factory Settings' main menu.
2. Select Celsius, Kelvin or Fahrenheit for setpoint unit.
3. Select psi or bar for refrigeration condensing pressure.
4. Select Celsius, Kelvin or Fahrenheit for liquid outlet temp.
5. Select Celsius, Kelvin or Fahrenheit for condensing temp.
6. Select whether to display PID with or with a % symbol.

		Maintenance		
		PARAM./VALUE	PARAM./VALUE	
		2 Parameter 1 Check Fluid Level	Parameter 2 Fluid Change	SET 5.0°C
1		Parameter 3 Clean Condensor	Parameter 4 Check Intern. Leaks	
		Parameter 5 Clean Intern. Debris	Parameter 6 Replace Fan	

### Maintenance Parameters





1. Return to 'Factory Settings' main menu.
2. Rename, delete or add new text for reminders.

		Limits / Alarms		
		PARAM./VALUE	PARAM./VALUE	
		2 Min Pressure 30	3 Max Pressure 170	SET 5.0°C
1		-	4 Max Temperature 50.0	
		-	-	

### Limits & Alarms

1. Return to 'Factory Settings' main menu.
2. Error log entered when pressure drops lower than setting.
3. Error log entered when pressure runs higher than setting.
4. Error log entered when temperature runs over setting.

Where values are exceeded, a pop-up note appears.

		Modbus		
		PARAM./VALUE	PARAM./VALUE	
		3 Slave address 1	4 Start address 0	SET 5.0°C
1		5 R/W Permission RW	6 Baud Rate 9600	
2		7 Parity NONE	8 Duplex HALF	

### RS485 MODBUS

Only XTD043RB-K620F model can run MODBUS.

1. Return to 'Factory Settings' main menu.
2. (Not pictured); single option to enable or disable MODBUS.
3. Set unique address in a multi-system RS485 network.
4. Select start address.
5. Direction of data, select read-write, or read-only.
6. Data transmission rate.
7. Select odd or even.
8. Select half or full; standard ATC wiring is 3-wire half duplex.

## DOCUMENT DETAILS

Date 5/DEC/2019 Author(s) MJH Page 7 / 9 Revision 1

		Compr. Settings		
		PARAM./VALUE	PARAM./VALUE	
	<b>2</b>	Comp. Min Freq [Hz] 40	<b>3</b>	Comp. Max Freq [Hz] 200
<b>1</b>	<b>4</b>	Comp. Err. Time [s] 60	<b>5</b>	Comp. Stop Freq [Hz] 30
		-		-
		-		-

### Compressor Settings

*This variable speed compressor has been carefully set up by ATC to work within manufacturer's limits.*

1. Return to 'Factory Settings' main menu.
2. Compressor minimum frequency (40Hz is 20% duty).
3. Compressor maximum frequency (200Hz is 100% duty).
4. When a compressor error occurs, the compressor times out for 60s. This is enforced by compressor control PCB.
5. Frequency issued to instruct the compressor to stop.

		Fan Settings		
		PARAM./VALUE	PARAM./VALUE	
	<b>2</b>	Fan Min Duty [%] 17	<b>3</b>	Fan Max Duty [%] 45
<b>1</b>	<b>4</b>	Fan Offset [%] 10	<b>5</b>	Fan Freq [kHz] 50
	<b>6</b>	Fan Mode A	<b>7</b>	Fan Delay [s] 10

### Fan Settings

*Fan performance is closely linked to overall refrigeration system health. ATC caution users against making changes.*

1. Return to 'Factory Settings' main menu.
2. To avoid stalling, the minimum duty default is 17%.
3. To ensure proportional control, the max duty is 45%.
4. Speed offset by fixed value above algorithm requirement.
5. Pulsed control frequency. Set to suit specific fan.
6. Switch between manual and automatic control.
7. Inrush current prevention, if compressor starts at same time.

		Calibration		
		PARAM./VALUE	PARAM./VALUE	
	<b>2</b>	OUT off-set -1	<b>3</b>	Pcond off-set 0.0
<b>1</b>		-		-
		-		-

### Calibration (Temperature & Pressure)

*In the unlikely event your chiller requires a replacement PT100 or pressure sensor, the previous calibration value(s) may no longer be valid.*

1. Return to 'Factory Settings' main menu.
2. Used by the factory to set difference between actual outlet temperature and that seen by the PT100 probe, in order to display real temperature.
3. Allows the factory to set pressure offset between measurement taken from calibrated gauge and that seen by pressure transducer.

		Set Points		
		PARAM./VALUE	PARAM./VALUE	
	<b>2</b>	Default Set Point 5.0	<b>3</b>	Enable Default NO
<b>1</b>	<b>4</b>	Min Set Point -5.0	<b>5</b>	Pwr Fail Restart NO
	<b>6</b>	Max Set Point 30.0		-

### Setpoint Defaults

1. Return to 'Factory Settings' main menu.
2. If unit is switched off and on again, with 'Enable Default' (2) active, the default setpoint overrides the last manual setpoint.
3. After power cycling, a default setpoint can be enforced to prevent chiller moving back to a previous unwanted setpoint.
4. Minimum settable temperature by user.
5. If power is cut when chiller is running (past 'process start'), the restoration of power reverts the operating state to that before the cut.
6. Maximum settable temperature by user.



Display Settings			
	PARAM./VALUE	PARAM./VALUE	
	Rotation	Brightness	SET 5.0°C
1	2 0	3 100	
	-	-	←
	-	-	⚙️

### Display Settings

1. Return to 'Factory Settings' main menu.
2. Rotation of screen through 180 degrees to improve viewing angle if unit is to be situated above or below eyeline.
3. Set display backlight strength.

SELECT THEME			
	LIGHT THEMES	DARK THEMES	
	Light 1	Dark 1	SET 5.0°C
1	2 3		
	Light 2	Dark 2	←
	Light 3	Dark 3	
	Light 4	Dark 4	←
	Light 5	Dark 5	
2	Light 6	Dark 6	⚙️

### Color Theme

1. Return to 'Factory Settings' main menu.
2. Scroll through color options.
3. Tap to select color choice.

Date/Time			
	PARAM./VALUE	PARAM./VALUE	
	Hours	Minutes	SET 5.0°C
1	2 8	47	
	Day	Month	←
	28	11	
	Year	Time Format	⚙️
	2019	12	

### Date & Time, Real Time Clock

*Incorrect setting of this clock will result in log entries and maintenance prompts referencing date and time incorrectly.*





1. Return to 'Factory Settings' main menu.
2. Tap each individual setting to make text appear red. Tap the red arrows either side to adjust value. Tap the red value to confirm entry.

File Paths			
	PARAM./VALUE	PARAM./VALUE	
	Prog File Prefix	Prog File Path	SET 5.0°C
1	2 PRG	EMMC/	
	Log File Prefix	Log File Path	←
	3 LOG	EMMC/	
	Temp XRef Prefix	Temp XRef Path	⚙️
	TXR	EMMC/	

### File Paths





1. Return to 'Factory Settings' main menu.
2. For programs created on the controller, a prefix can be edited to personalize the files.
3. Log files generated can have customized prefix.

*It is not recommended to adjust any other values.*

		PID Cooling		
		PARAM./VALUE	PARAM./VALUE	
	3	Kp (1.5) 1.2	Ki (10.0) <sup>3</sup> 8.0	SET 5.0°C
1 	5	Kd (0.5) 0.6	Kt [s] 1.0	
2 	7	Delay [s] 20	Threshold [°C] 0.3	





### PID Cooling Settings (1)

1. Return to 'Factory Settings' main menu.
2. Scroll down for more settings.
3. Proportional term adjustment for cooling behavior.
4. Integral term adjustment for cooling behavior.
5. Derivative term adjustment for cooling behavior.
6. Cannot adjust – this is time for a single PID loop.
7. Time elapsed until cooling PID changes to heating mode.
8. Delay counter (7) starts after overshoot exceeds this value.

		PID Cooling		
		PARAM./VALUE	PARAM./VALUE	
2 	3	Heating Switch NO	Fast Start YES	SET 5.0°C
1 	5	Anti-Windup [°C] 2.0	Prop. Band [°C] 2.2	
		-	-	





### PID Cooling Settings (2)

1. Return to 'Factory Settings' main menu.
2. Scroll up for more settings.
3. Allow heating mode to function via the solenoid valve.
4. 'Yes' enables compressor to start running immediately.
5. Integral term removed from PID calculation inside set range.
6. Outside this limit, P-band control is 'on-off', i.e. 0 or 100%.

		PID Heating		
		PARAM./VALUE	PARAM./VALUE	
	3	Kp (1.5) 1.2	Ki (10.0) <sup>3</sup> 8.0	SET 5.0°C
1 	5	Kd (0.5) 0.6	Kt [s] 1.0	
2 	7	Delay [s] 20	Threshold [°C] 0.3	

### PID Heating Settings (1)

1. Return to 'Factory Settings' main menu.
2. Scroll down for more settings.
3. Proportional term adjustment for heating behavior.
4. Integral term adjustment for heating behavior.
5. Derivative term adjustment for heating behavior.
6. Cannot adjust – this is time for a single PID loop.
7. Time elapsed until heating PID changes to cooling mode.
8. Delay counter (7) starts after overshoot exceeds this value.

		PID Heating		
		PARAM./VALUE	PARAM./VALUE	
2 	3	Cooling Switch NO	Fast Start NO	SET 5.0°C
1 	5	Anti-Windup [°C] 2.0	-	
		-	-	

### PID Heating Settings (2)

1. Return to 'Factory Settings' main menu.
2. Scroll up for more settings.
3. Allow cooling mode to function via solenoid valve.
4. 'Yes' enables compressor to start running immediately.
5. Integral term removed from PID calculation inside set range.



Applied Thermal Control Ltd  
39 Hayhill Industrial Estate  
Barrow-upon-Soar, Loughborough  
LE12 8LD, United Kingdom  
+44 (0) 1530 839 998  
Service@thermalexchange.co.uk  
Support@app-therm.com

# Annex F-1

## DOCUMENT DETAILS

Date	29/NOV/2019	Compiled by	MJH	Revision	1
------	-------------	-------------	-----	----------	---

### PRESSURE AND FLOW ADJUSTMENT IN MINI CHILLER WITH CENTRIFUGAL PUMP

The Mini is available with a range of pump options. Low pressure requirements are best served by the quieter and mechanically looser centrifugal types – the flow of these items is dictated by the backpressure of the pipework through which it must pump. Reviewing the pump flow curve can indicate the flow expected. Centrifugal pumps have such a limited maximum pressure, that the water circuit components alone can hold the pressure, and no pressure relief valve is fitted.

If further limitation of pressure is required, a flow control valve can be fitted to either the outlet or inlet of the chiller, depending on whether the application is to be pressurized or not.



Applied Thermal Control Ltd  
 39 Hayhill Industrial Estate  
 Barrow-upon-Soar, Loughborough  
 LE12 8LD, United Kingdom  
 +44 (0) 1530 839 998  
 Service@thermalexchange.co.uk  
 Support@app-therm.com

# Operating Manual; Troubleshooting Annex G-1

## DOCUMENT DETAILS

Date	29/NOV/2019	Author(s)	MJH	Page	1 / 1	Revision	1
------	-------------	-----------	-----	------	-------	----------	---

## MINI GENERIC INITIAL TROUBLESHOOTING

Symptom	Potential Cause(s)
Compressor not running	Check the connection of the compressor power plug situated on top of the compressor itself.
	Check the connection of the signal line from the controller to the compressor PCB control board.
	The compressor has built-in logic issued via its PCB control board – board error states are communicated to the main touchscreen controller.
Noisy operation	Usually bearing failure in rotating machinery causes noise – this might be the cooling fan, the compressor or the pump. Pay attention to specific components to identify the source of noise.
Fluid lines becoming fouled / containing biological matter	Not using opaque tubing can lead to UV light passing through the tubing, prompting growth of organisms.
	Not following maintenance schedule for cleaning/flushing.
Fluid seen leaking from system	Your fluid may be incompatible with the materials used in chiller construction. Contact ATC to ensure the fluid is compatible.
	Rapid changes in system temperature can cause some materials to change shape at a faster rate than others. Contact ATC to discuss alternative materials and parts in water circuit construction.
Poor cooling capacity (undercooling)	Check for any error states on the compressor – the controller will indicate if an error has occurred – tapping to clear will allow refrigeration to continue.
	This can be caused by 1) excess application thermal heat load, 2) excess ambient temperature, 3) fan failure, or 4) controller issues with fan speed or compressor control.
Excess cooling capacity (overcooling)	Check behavior of heating solenoid valve – if no power reaches the coil, or if it jammed closed, cooling may continue to occur.
	Check value that system seeing for 'OUT' liquid temperature. A value reported that is higher than actual will force the system to cool without need.
Following period of being powered-down, chiller no longer retains correct time and date settings.	When no mains power is provided to the chiller, a PCB-mounted button cell is used to power the real time clock (RTC). This is a lithium cell with Panasonic part number BR-1225/BN. The item is UL-approved under file number MH12210. ATC provide approved replacements.



Applied Thermal Control Ltd  
 39 Hayhill Industrial Estate  
 Barrow-upon-Soar, Loughborough  
 LE12 8LD, United Kingdom  
 +44 (0) 1530 839 998  
 Service@thermalexchange.co.uk  
 Support@app-therm.com

Operating Manual; Maintenance for End-Users

# Annex H-1

**DOCUMENT DETAILS**

Date November 2019

Compiled by MJH

Revision 1

**PERIODIC MAINTENANCE REQUIREMENTS BY END USER**



Caution; Failure to carry out service at the specified intervals may permanently damage your equipment.

Print this sheet out and display close to the chiller to maximize the visibility of maintenance requirements.

Weekly	Week 1	Week 2	Week 3	Week 4
Check fluid level – top up as required.				

Monthly	J	F	M	A	M	J	J	A	S	O	N	D
Check the condenser is free from dust or accumulation of debris.												

Annually	Y1	Y2	Y3	Y4	Y5	Y6	Y7	Y8
Drain process fluid and replace with fresh fluid.								
Check for fluid leaks throughout chiller and application.								
Clear any debris from inside the chiller.								

A vacuum cleaner is recommended for cleaning out the condenser, while soft cloths and IPA are recommended for cleaning metallic surfaces. If any spillages have occurred, best practice is to allow the water to evaporate off and wipe up remaining glycol residue with a cloth. Always clean with power supply isolated.



Caution; Never blow out the condenser with compressed air.



Caution; If the mains lead is lost or damaged, contact ATC who will be able to supply a replacement of the correct specification.



# Annex I-1

## DOCUMENT DETAILS

Date	29/NOV/2019	Author(s)	MJH	Page	1 / 1	Revision	1
------	-------------	-----------	-----	------	-------	----------	---

## GENERIC MAINTENANCE FOR TECHNICIANS



Warning; Opening the refrigeration system may expose the operative to toxic and corrosive compounds (HF). Take protective measures including suitable eye protection.



Warning; Gases may exceed 300 psi (20 bar) during operation.



Warning; All refrigerants do not support combustion and are asphyxiating gases.



Warning; After switching off, the condenser cooling fan blades continue to rotate. Do not attempt servicing whilst the blades are rotating.



Warning; All chillers contain water and electricity in close proximity. Ensure the unit is isolated before service. The Mini is protected from overcurrent by fuses on the mains inlet. Never bypass the fuses.

Following service or repair by a trained technician;

- a) Ensure any electrical connections that may have been disturbed are given the 'tug-test'
- b) Ensure earth bonding conductors are re-attached.
- c) Ensure the correct fuses are in place.
- d) Ensure the mains cord being used is to specification, and is free from damage
- e) Subject the unit to a PAT test to ensure the unit is safe before running.
- f) Ensure there are no leaks inside or outside the unit.
- g) Using the wiring schematic for guidance, simulate faults to check each interlock's function.



Applied Thermal Control Ltd  
 39 Hayhill Industrial Estate  
 Barrow-upon-Soar, Loughborough  
 LE12 8LD, United Kingdom  
 +44 (0) 1530 839 998  
 Service@thermalexchange.co.uk  
 Support@app-therm.com

Operating Manual; Declarations & Approvals

# Annex J-1

### DOCUMENT DETAILS

Date	6/JAN/2020	Author(s)	MJH	Page	1 / 1	Revision	3
------	------------	-----------	-----	------	-------	----------	---

### EU DECLARATION OF CONFORMITY

Document layout; Governed by Machinery Directive 2006/42/EC, Annex II.

### REGISTERED BUSINESS ADDRESS

Applied Thermal Control Ltd, 39 Hayhill Industrial Estate, Barrow-upon-Soar, Loughborough, LE12 8LD, UK.

### AUTHORISATION TO COMPILE THE TECHNICAL FILE

Mitchell Howard, Applied Thermal Control Ltd, 39 Hayhill Industrial Estate, Barrow-upon-Soar, Loughborough, LE12 8LD, UK.

### DESCRIPTION & IDENTIFICATION OF MACHINERY

Generic denomination;	Mini-Series.
Function;	Recirculating chiller
Model;	All with 'M' prefix.
Type;	Air-cooled or water-cooled vapour compression-based.
Serial number;	
Commercial name;	As above.

### NOTIFIED BODY

Not applicable

### QUALITY ASSURANCE SYSTEM

QMS International Ltd, Muspole Court, Muspole Street, Norwich, NR3 1DJ, United Kingdom.  
 ASCB Registered; 201409-2

### DECLARATION

The manufacturer declares that the machinery described above fulfils all the relevant provisions of the;

- Machinery Directive 2006/42/EC.
- EMC Directive 2014/30/EU, via harmonised standards;
  - IEC 61000-6-2:2005 (Immunity for industrial environments).
  - IEC 61000-6-4:2006 +A1:2011 (Emission for industrial environments).
- Low Voltage Directive 2014/35/EU.
- RoHS Directive 2011/65/EU (RoHS 2);
  - The machinery above contains no Lead (Pb), Mercury (Hg), Cadmium (Cd), Hexavalent Chromium (Cr6+), Polybrominated Biphenyls (PBB) or Polybrominated Diphenyl Ether (PBDE).
- RoHS Directive (EU) 2015/863 (RoHS 3);
  - Bis(2-Ethylhexyl) phthalate (DEHP): < 1000 ppm
  - Benzyl butyl phthalate (BBP): < 1000 ppm
  - Dibutyl phthalate (DBP): < 1000 ppm
  - Diisobutyl phthalate (DIBP): < 1000 ppm

### PERSON EMPOWERED TO DRAW UP DECLARATION

Robert Poniatowski, CEO

Signed in Barrow-upon-Soar, UK, date 6/JAN/2020



**Applied Thermal Control Ltd**  
 39 Hayhill Industrial Estate  
 Barrow-upon-Soar, Loughborough  
 LE12 8LD, United Kingdom  
 +44 (0) 1530 839 998  
 Service@thermalexchange.co.uk  
 Support@app-therm.com

# Annex J-5

**DOCUMENT DETAILS**

Date	6/JUL/2020	Author(s)	MJH	Page	1 / 1	Revision	1
------	------------	-----------	-----	------	-------	----------	---

**CONFLICT MINERALS COMPLIANCE STATEMENT**

Applied Thermal Control (ATC) adheres to and embraces the ethical values that support our everyday activities. As an expression of these principles and ethical values, ATC adheres to the principle of responsible sourcing of components containing precious and non-precious metals and metal salts in compliance with applicable laws and regulations.

The metals considered are Tantalum (Ta), Tungsten (W), Tin (Sn) and Gold (Au). ATC actively sources components from suppliers known to be reputable and could demonstrate compliance upon request with the Conflict Minerals acts and guidelines.

ATC uses Gold and Tin in electrical components, on PCBs and in rotating machinery, as governed by technical requirements of products. These metals could potentially originate from conflict mineral sites. As many of our suppliers do not purchase these metals direct from smelters, both they and ATC must rely heavily on information that will be provided by their suppliers to determine the source and chain of the metals in those products.

ATC is committed to working with its customers and supply chain to meet the customer’s specification and requirements with regards to traceability, sourcing requirements and restrictions. ATC commits that, to the best of our knowledge, our suppliers are complying with the conflict minerals act as stated in their documentation. These statements are reviewed, and updates obtained as required.

Mitchell Howard, Technical Manager  
 Signed in Coalville, UK, date 6/JUL/2020





Applied Thermal Control Ltd  
39 Hayhill Industrial Estate  
Barrow-upon-Soar, Loughborough  
LE12 8LD, United Kingdom  
+44 (0) 1530 839 998  
Service@thermalexchange.co.uk  
Support@app-therm.com

# Annex J-7

## DOCUMENT DETAILS

Date	15/JUL/2020	Author(s)	MJH	Page	1 / 1	Revision	1
------	-------------	-----------	-----	------	-------	----------	---

### WHAT IS THE REACH REGULATION 1907/2006?

REACH is a regulation of the European Union, adopted to improve the protection of human health and the environment from the risks that can be posed by chemicals, while enhancing the competitiveness of the EU chemicals industry. REACH places the burden of proof on companies. To comply with the regulation, companies must identify and manage the risks linked to the substances they manufacture and market in the EU. They have to demonstrate to ECHA how the substance can be safely used, and they must communicate the risk management measures to the users. If the risks cannot be managed, authorities can restrict the use of substances in different ways. In the long run, the most hazardous substances should be substituted with less dangerous ones. REACH stands for Registration, Evaluation, Authorization and Restriction of Chemicals. It entered into force on 1/JUN/2007.

### REACH 'ARTICLE' COMPLIANCE CONSIDERATIONS

#### REACH ANNEX XVII COMPLIANCE

Substances under Annex XVII are restricted either in full (not to be used at all) or for specific uses (can be used in some uses but cannot be used in identified uses).

Applied Thermal Control has contacted all our suppliers and to the best of our knowledge, none of the articles that we sell intentionally contain any of the Annex XVII substances currently on the candidate list in concentrations of >0.1% by weight.

#### REACH ANNEX XIV COMPLIANCE

Substances under Annex XIV require authorization to use in the EU after sunset date, require communication to downstream recipients when over threshold (0.1% w/w at article level) and require notification to ECHA when SVHC over threshold and imported over 1000kg annually and use not already registered.

Applied Thermal Control has contacted all our suppliers and to the best of our knowledge, none of the articles that we sell intentionally contain any of the Annex XVII substances currently on the candidate list in concentrations of >0.1% by weight.

#### SVHC LIST COMPLIANCE

Substances of Very High Concern (SVHC) require communication to downstream recipients when over threshold (0.1% w/w at the article level), notification to the European Chemicals Agency (ECHA) when SVHC over threshold and when imported over 1000kg annually and use not already registered.

Applied Thermal Control has contacted all our suppliers and to the best of our knowledge, none of the articles that we sell intentionally contain any of the Annex XVII substances currently on the candidate list in concentrations of >0.1% by weight.

### DECLARATION

Mitchell Howard, Technical Manager  
Signed in Barrow-upon-Soar, UK, date 15/JUL/2020



Applied Thermal Control Ltd  
39 Hayhill Industrial Estate  
Barrow-upon-Soar, Loughborough  
LE12 8LD, United Kingdom  
+44 (0) 1530 839 998  
Service@thermalexchange.co.uk  
Support@app-therm.com

# Annex J-8

## DOCUMENT DETAILS

Date	27/AUG/2020	Author(s)	MJH	Page	1 / 1	Revision	1
------	-------------	-----------	-----	------	-------	----------	---

## WHAT IS THE POPs REGULATION 2019/1021?

POPs stands for persistent organic pollutants. In Europe, the global Stockholm Convention is implemented through POPs legislation. POPs are organic substances that persist in the environment, accumulate in living organisms and pose a risk to our health and the environment. They can be transported by air, water or migratory species across international borders, reaching regions where they have never been produced or used. International risk management is necessary as no region can manage the risks posed by these substances alone.

The European Parliament (and Council) issued regulation 2019/1021 on 20/JUN/2019, and further amended (regulation 2020/784) on 8/APR/2020.

## POP<sub>s</sub> LISTED UNDER INITIAL REGULATION 2019/1021

### Pesticides;

Aldrin, Chlordane, DDT, Dieldrin, Endrin, Heptachlor, Hexachlorobenzene, Mirex, Toxaphene.

### Industrial Chemicals;

Hexachlorobenzene, Polychlorinated Biphenyls (PCBs).

### Industrial Chemical Byproducts;

*Hexachlorobenzene byproducts;*

Polychlorinated dibenzo-p-dioxins and polychlorinated dibenzofurans (PCDD/PCDF), and PCBs.

## POP<sub>s</sub> LISTED UNDER AMENDMENT 2020/784

Perfluorooctanoic acid (PFOA), its salts and PFOA-related compounds.

## POP<sub>s</sub> COMPLIANCE STATEMENT

We certify that to the best of our knowledge, based upon up-to-date information from our suppliers, all products supplied by Applied Thermal Control are fully POPs compliant in accordance with regulations and amendments above mentioned.

## DECLARATION

Mitchell Howard, Technical Manager  
Signed in Barrow-upon-Soar, UK, date 27/AUG/2020



## DOCUMENT DETAILS

Date	23/JUN/2020	Author(s)	RW, MJH	Page	1 / 1	Revision	2
------	-------------	-----------	---------	------	-------	----------	---

## WARRANTY TERMS

Please visit the website warranty registration page to ensure ATC can offer you the best possible support;

<https://www.app-therm.com/warranty-registration/>

**a) For how long is my ATC product warrantied?**

ATC provides a comprehensive return to base 2-year parts, 1-year labor warranty from delivery as standard on all new equipment, provided it has been installed and operated in accordance with the manual.

**b) Where will ATC fulfill the product warranty?**

ATC's standard warranty terms are Return to Base (RTB) – issues with chillers are often easily solvable over the phone or email, or by reviewing ATC's technical guidance on the web and in the product manual. On occasion, at the discretion of ATC, goods may be serviced on site FOC or a service loan unit may be supplied. Warranty cover excludes the cost of travel by engineers and loan unit rental charges. Obtaining onsite service for a product, even in full warranty, is a chargeable service.

**c) Who is liable for shipping charges in the event of warranty failure?**

During the **first year** of the warranty period, freight costs for shipping to ATC are for the customer's account. Freight costs for shipping from ATC are for ATC's account.

During the **second year** of the warranty, freight costs to and from ATC are for the customer's account.

**d) I'm experiencing problems with my chiller. It's within warranty – what do I do next?**

Contact ATC to discuss the issue you are having. The contact details in the header of this document are an ideal place to start. Be sure to have your model number and serial number on-hand to aid those attempting to solve remotely.

**e) Telephone support couldn't fix my chiller – what do I do next?**

An RMA form must be completed. This allows both the end-user and ATC to clarify your details, to set the party responsible for shipping costs, and to set a different return address if desired. Shipping advice is provided, and the end-user must sign a declaration that states the unit is safe to handle. Return the form by email for fastest response.

**f) What happens if my chiller failed outside warranty or requires non-warranty repair work?**

A purchase order will be requested to cover an initial inspection – this will only be invoiced if the inspection shows there is no fault. If packaging is required, i.e. a crate, a separate charge will be levied. If the end user prefers ATC to arrange a collection, a shipping charge may be levied.

**g) Our process must continue running – can we have a loan unit whilst our chiller is in repair?**

ATC hold several standard air-cooled chillers at the factory for the sole purpose of offering for loan – these are available on a first-come, first-serve basis. Models up-to 3kW capacity are available.



## **ModBUS® Communication Protocol for the ATC MINI Chiller**

**Applied Thermal Controls Limited**  
**Gee Rd, Coalville LE67 4NB, UK**  
**Email: sales@app-therm.com**  
**Tel: +44 (0)1530 839998**

### **OVERVIEW**

The ATC MINI Chiller uses the ModBUS® RTU communication protocol over RS485 networks  
All communication messages finish with a check sum type CRC (cyclic redundancy check).

Every slave device in a network must have a different address.

The protocol allows one master only and up to 247 slaves.

Only the master unit can start communication by the transmitting the address  
of the intended slave unit and the command to execute.

Only the slave unit having the matching address will answer to the master.

Remote control via RS485 has priority over local MINI Chiller settings.

The serial transmission characteristics are programmable within  
the ATC MINI Chiller Parameter Menu Modbus

#### **Settings**

Slave device address: 1 to 247

Baud rate: 4800, 9600, 19200, 38400, 115200 bits per second

Byte Format: 1 start bit, 8 data bits, optional parity bit (odd, even, none) and 1 stop bit

2 wire (half duplex) and 4 wire (full duplex) RS485 communication is supported

Termination resistors (120R) are required at each end of the RS485 network

# ATC Mini Chiller - ModBUS Communication Protocol

## 1 Physical Connection

The ATC MINI Chiller is provided with an RS485 serial communication interface, insulated to 1kV so that any problem arising from ground potential is removed. While idle, the MINI Chiller is in a receive condition and only undertakes transmission after a message has been decoded that matches the configured address. If the checksum and data format is correct, an OK is transmitted (code 0) but if an error occurred, an error code (1+) is sent back to the master.

The MINI Chiller is equipped with terminals named Tx+, Tx-, Rx+, Rx- and 0V to support 4 wire (full duplex) or 2 wire (half duplex) networks. The connection between slaves is wired in parallel according to the diagrams below. A termination resistor of 120R is required at either end of the RS485 network wired pairs to prevent signal reflection problems. A common earth or 0V line is preferred to ensure stability and transient suppression within the system. The line can be up to 1000 meters in length and support up to 31 slaves without a repeater buffer.

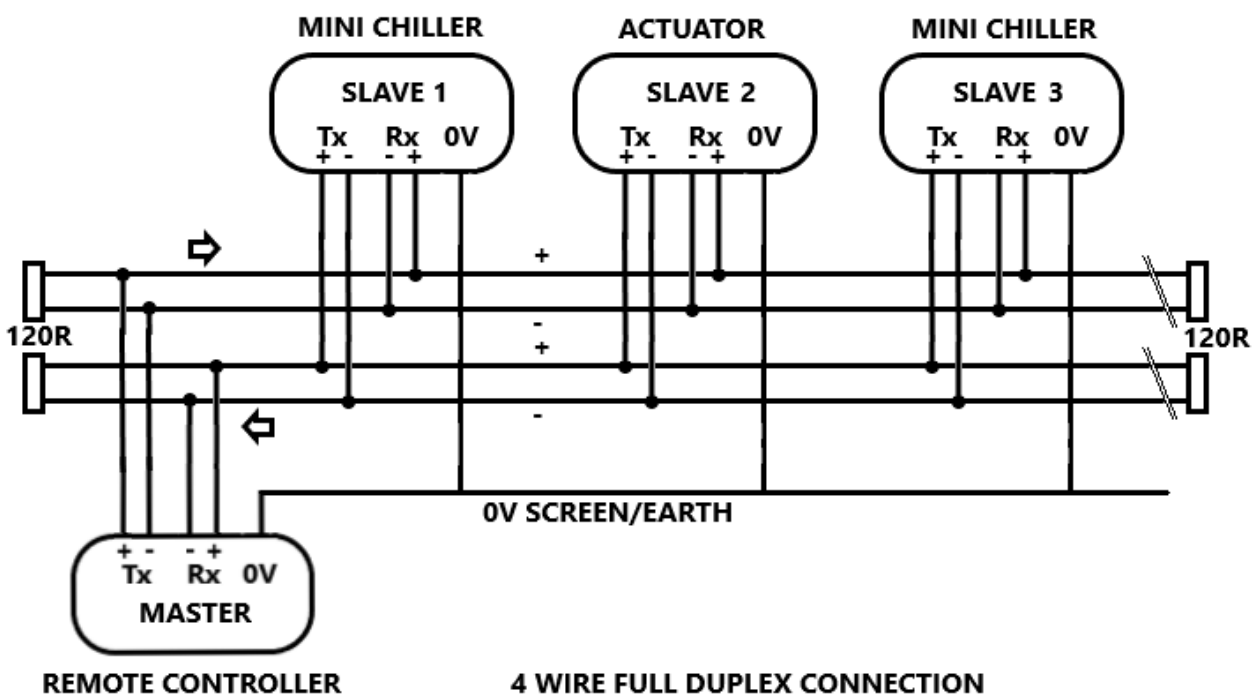
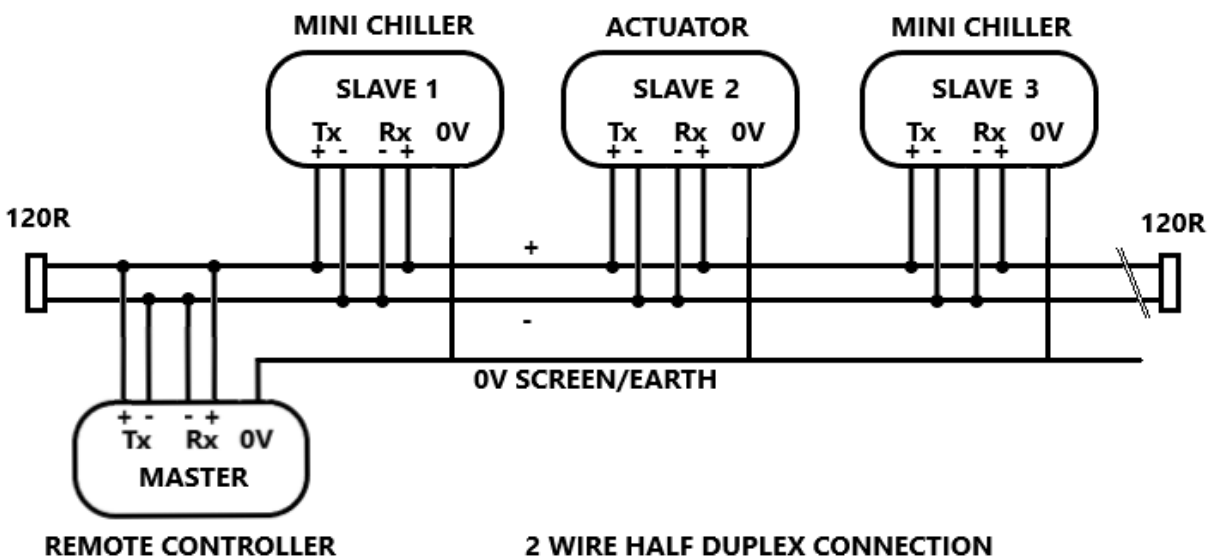

# ATC Mini Chiller - ModBUS Communication Protocol

## 2 Communication Protocol

The protocol adopted by the ATC MINI Chiller is a subset of the widely used MODBUS RTU (JBUS, AEG Schneider Automation, Inc. registered trademark) protocol, so that connections are easy for many commercial PLCs and supervisory programs.

The MODBUS RTU communication functions implemented are:

From master to slave	From slave to master
Function 3: read n registers request	Function 3: return data content of n registers
Function 6: set one register request	Function 6: set one register and acknowledge
Function 16: set multiple registers request	Function 16: set multiple registers and acknowledge

Every message contains four fields: Slave Id, Function, Data, CRC

Slave address (from 1 to 247): MODBUS RTU (JBUS) reserves address 0 not used in MINI Chiller

Function code: contains 3, 6 or 16

Data field: contains data for the function used like register address, number of registers and actual data;

Check word: a cyclic redundancy check (CRC) performed with particular rules for CRC16.

### Cyclic Redundancy Check

The CRC is a check word that permits verification of message integrity.

Every message, sent or received, has the CRC check word in the two last characters .

After receiving a request, the slave checks the received message by comparing the received CRC with the calculated one.

When a reply is ready to be sent by the slave, it calculates the CRC word and adds two characters to the prepared message.

CRC calculation is performed on every character of the message, excluding the last two bytes being the CRC.

### Error Condition Response

Data	Byte
Slave address	1
Function code + 128	1
Error code	1
CRC-16 (LSB)	1
CRC-16 (MSB)	1

Errors generate a code indicating the cause as follows: 00H = No Error

01H = Illegal Function – code received by the slave device is not recognized

02H = Illegal Data Address – the address does not exist in the slave

03H = Illegal Data Value – the value is not accepted by the slave

04H = Slave Device Failure – an unrecoverable error occurred during slave processing

05H = Acknowledge – the slave accepts the data but needs timeout extension

06H = Slave Busy – the master should try again later

07H = NACK – the slave cannot perform the command, master should request diagnostic

## ATC Mini Chiller - ModBUS Communication Protocol

**Function Code 3 is used by the master to read a group of sequential registers present in the slave.**

Master request	
Data	Bytes
Slave address (1... 247)	1
Function code (3)	1
First register address (Most Significant Byte)	1
First register address (Least Significant Byte)	1
Number of requested registers (MSB)	1
Number of requested registers (LSB)	1
CRC-16 (LSB)	1
CRC-16 (MSB)	1

Slave reply	
Data	Bytes
Slave address (1... 247)	1
Function code (3)	1
Byte number (n)	1
Data	n
CRC-16 (LSB)	1
CRC-16 (MSB)	1

Each register is 16 bits in length so 2 bytes are required for data. The first byte represents the MSB (Most Significant Byte) while the second byte represent the LSB (Least Significant Byte). For 32 bit floating point numbers, 2 registers (4 bytes) are required.

Example: The master requests slave address 1 to return the values of registers 25 and 26 (0x19 and 0x1A).

Master request	
Data	Byte (Hex)
Slave address	01
Function code (3 = read )	03
First register address (MSB)	00
First register address (LSB)	19
Number of requested registers (MSB)	00
Number of requested registers (LSB)	02
CRC-16 (LSB)	15
CRC-16 (MSB)	CC

Slave reply	
Data	Byte (Hex)
Slave address	01
Function code (3 = read)	03
Byte number	04
Value of the first register (MSB)	00
Value of the first register (LSB)	0A
Value of the second register (MSB)	00
Value of the second register (LSB)	14
CRC-16 (LSB)	DA
CRC-16 (MSB)	3E

The slave reply means register 25 = 0AHex (10 decimal) and register 26 = 14H (20 decimal).

## ATC Mini Chiller - ModBUS Communication Protocol

**Function Code 6 is used by the master to write data to a single register present in the slave.**

<b>Master request</b>	
Data	Bytes
Slave address	1
Function code ( 6 )	1
Register address (MSB)	1
Register address (LSB)	1
Value to write (MSB)	1
Value to write (LSB)	1
CRC-16 (MSB)	1
CRC-16 (LSB)	1

<b>Slave reply</b>	
Data	Bytes
Slave address (1-255)	1
Function code ( 6 )	1
Register address (MSB)	1
Register address (LSB)	1
Written value (MSB)	1
Written value (LSB)	1
CRC-16 (MSB)	1
CRC-16 (LSB)	1

Example: The master requests slave address 1 to write in memory location 770 (0x302) the value 10 (0x0A).

<b>Master request</b>	
Data	Byte (Hex)
Slave address	01
Function code ( 6 )	06
Register address (MSB)	03
Register address (LSB)	02
Value to write (MSB)	00
Value to write (LSB)	0A
CRC-16 (MSB)	A8
CRC-16 (LSB)	49

<b>Slave reply</b>	
Data	Byte (Hex)
Slave address	01
Function code ( 6 )	06
Register address (MSB)	03
Register address (LSB)	02
Written value (MSB)	00
Written value (LSB)	0A
CRC-16 (MSB)	A8
CRC-16 (LSB)	49



## ATC Mini Chiller - ModBUS Communication Protocol

**Function Code 16 is used by the master to write data to multiple sequential registers in the slave.**

Master request	
Data	Byte (Hex)
Slave address (1-254)	1
Function code ( 16 )	1
First register address (MSB)	1
First register address (LSB)	1
Number of requested registers (MSB)	1
Number of requested registers (LSB)	1
Byte count	1
Values	n
CRC-16 (LSB)	1
CRC-16 (MSB)	1

Slave reply	
Data	Byte (Hex)
Slave address (1-254)	1
Function code (16 )	1
First register address (MSB)	1
First register address (LSB)	1
Number of written registers (MSB)	1
Number of written registers (LSB)	1
CRC-16 (LSB)	1
CRC-16 (MSB)	1

Example: The master unit requires to the slave 1 to write in the registers 10314 (0x284A) and 10315 (0x284B) the values 100 (0x64) and 200 (0xC8)

Master request	
Data	Byte (Hex)
Slave address	01
Function code ( 16 )	10
First register address (MSB)	28
First register address (LSB)	4A
Number of requested registers (MSB)	00
Number of requested registers (LSB)	02
Byte count	4
Value 1 (MSB)	00
Value 1 (LSB)	64
Value 2 (MSB)	00
Value 2 ((LSB)	C8
CRC-16 (LSB)	C9
CRC-16 (MSB)	A8

Slave reply	
Data	Byte (Hex)
Slave address	01
Function code ( 16 )	10
First register address (MSB)	28
First register address (LSB)	4A
Number of written registers (MSB)	00
Number of written registers (LSB)	02
CRC-16 (LSB)	69
CRC-16 (MSB)	BE

## ATC Mini Chiller - ModBUS Communication Protocol

### 3 Register Map

The ATC MINI Chiller slave address, register start address, write permission, baud rate, parity, duplex and enable are set in the ModBUS Parameter submenu accessible from the MINI Chiller user interface touch screen.

REG	HEX	WRITE/READ	FUNCTION	NOTE
0	00	WR/RD	Process Stop/Start	Integer – Stop=0, Start =1, use function 6 to write, 3 to read
1	01	WR/RD	SET Temperature	Float IEEE-754, use function 16 to write, 3 to read
2	02			
3	03	RD Only	OUT Temperature	OUT PT100 Sensor, Float IEEE-754, use function 3 to read
4	04			
5	05	RD Only	Subcooling Temperature	Subcooling PT100 Sensor, Float IEEE-754, use function 3 to read
6	06			
7	07	RD Only	Pressure Value	Pressure, Float IEEE-754, use function 16 to read
8	08			
9	09	RD Only	Calibrated fan speed	Integer %, use function 3 to read
10	0A	RD Only	Calibrated compressor speed	Integer %, use function 3 to read
11	0B	RD Only	Compressor error state	Integer see Mini Chiller product spec for values
12	0C	RD Only	Upper level switch state	Reg 13 = 0 – empty, 12=0 and 13=1 – half, 12=1 and 13=1 – full
13	0D	RD Only	Lower level switch state	
14	0E	RD Only	Maintenance 1 day	1-31
15	0F	RD Only	Maintenance 1 month	1-12
16	10	RD Only	Maintenance 1 year	1-65,535
17	11	RD Only	Maintenance 1 status	flag (0 (date done) / 1 (date due))
18	12	RD Only	Maintenance 2 day	1-31
19	13	RD Only	Maintenance 2 month	1-12
20	14	RD Only	Maintenance 2 year	1-65,535
21	15	RD Only	Maintenance 2 status	flag (0 (date done) / 1 (date due))
22	16	RD Only	Maintenance 3 day	1-31
23	17	RD Only	Maintenance 3 month	1-12
24	18	RD Only	Maintenance 3 year	1-65,535
25	19	RD Only	Maintenance 3 status	flag (0 (date done) / 1 (date due))
26	1A	RD Only	Maintenance 4 day	1-31
27	1B	RD Only	Maintenance 4 month	1-12
28	1C	RD Only	Maintenance 4 year	1-65,535
29	1D	RD Only	Maintenance 4 status	flag (0 (date done) / 1 (date due))
30	1E	RD Only	Maintenance 5 day	1-31
31	1F	RD Only	Maintenance 5 month	1-12
32	20	RD Only	Maintenance 5 year	1-65,535
33	21	RD Only	Maintenance 5 status	flag (0 (date done) / 1 (date due))
34	22	RD Only	Maintenance 6 day	1-31
35	23	RD Only	Maintenance 6 month	1-12
36	24	RD Only	Maintenance 6 year	1-65,535
37	25	RD Only	Maintenance 6 status	flag (0 (date done) / 1 (date due))
38	26	RD Only	Maintenance 7 day	1-31
39	27	RD Only	Maintenance 7 month	1-12
40	28	RD Only	Maintenance 7 year	1-65,535
41	29	RD Only	Maintenance 7 status	flag (0 (date done) / 1 (date due))

This Register Map is Copyright 2019 Applied Thermal Controls.

Please refer to the MINI Chiller Parameter Menu settings to establish the specific use of Maintenance 1 to 7.

## ATC Mini Chiller - ModBUS Communication Protocol

The offset (start) address of the registers can be adjusted in the MINI Chiller Modbus Parameter Menu.

Up to 41 registers can be read in any ModBUS Function 3 request, however if all are requested at the same time repeatedly, this may impact on performance. An interval of 10 seconds is recommended between requests.

Temperature values are sent according to the Temperature Units setting in the MINI Chiller Parameter Menu.  
Pressure values are sent according to the Pressure Units setting in the MINI Chiller Parameter Menu.



Applied Thermal Control Ltd  
 39 Hayhill Industrial Estate  
 Barrow-upon-Soar, Loughborough  
 LE12 8LD, United Kingdom  
 +44 (0) 1530 839 998  
 Service@thermalexchange.co.uk  
 Support@app-therm.com

Operating Manual; Recommended Spares

# Annex M-1

**DOCUMENT DETAILS**

Date	1/SEP/2020	Author(s)	AMI	Page	1 / 1	Revision	1
------	------------	-----------	-----	------	-------	----------	---

**RECOMMENDED SPARES FOR ATC MINI (M-SERIES) AND ECOMINI (EM-SERIES) CHILLERS**

Recommended spares include all rotating machinery (i.e. motors, fans), all sacrificial elements (i.e. fuses) and parts that users interact with (dials, fittings). Pricing is available from sales@app-therm.com.

**COMMON TO BOTH MINI AND ECOMINI**

PN	Description	QTY
WA697	Water Pump	1
RA282	Fridge Compressor	1
RA282	Compressor Controller	1
EA787	Compressor Cooling Fan	2
RA287	Fridge Condenser Fan	1
EA512	Power Inlet Fuse	2
EA769	Pump Fuse	1
EA764	DIN Rail Fuse Holder	1
WA643	Self-Sealing Water Bulkhead (SA00016)	2
WA644	Self-Sealing Water Connectors (SA00016)	2
WA642	12mm Push Fit Water Bulkhead	2
WA652	12mm Push Fit Plug	2
EA044	IEC Cordset	1
EA770	Power Inlet Connector Module	1
MA310	Rubber Mounting Feet	4
WA641	Fluid Tank Assembly	1

**COMMON TO MINI ONLY**

PN	Description	QTY
EA754	Power Supply	1
EA760	USB Port	1
EA755	Touch Screen Controller NON-RS485	1
EA778	Touch Screen Controller WITH-RS485	1
EA513	Controller Fuse	1
EA762	Pump Relay	1
EA759	Optical Level Switch	2
EA757	Pressure Transducer	1
EA586	RTD Temperature Probe PT100	1
RA285	Solenoid Coil	1

**COMMON TO ECOMINI ONLY**

PN	Description	QTY
EA815	Power Supply	1
EA019	NTC Temperature Probe assembly	1
EA812	Speed Control Potentiometer	1
EA813	Speed Control Dial	1
EA816	Low Temperature Cutoff Controller	1

# SAFETY DATA SHEET

according to Regulation (EU) 2015/830

Page 1/7

## Harp® 134a

Revision 0

Revision date 2017-06-21

### SECTION 1: Identification of the substance/mixture and of the company/undertaking

#### 1.1. Product identifier

Product name	Harp® 134a
REACH Registration Number	01-2119459374-33
CAS No.	811-97-2
EC No.	212-377-0

#### 1.2. Relevant identified uses of the substance or mixture and uses advised against

Product Use	[SU3] Industrial uses: Uses of substances as such or in preparations at industrial sites; ----- [SU22] Professional uses: Public domain (administration, education, entertainment, services, craftsmen);
Restricted use	[SU21] Consumer uses: Private households (= general public = consumers);
Description	Gas.

#### 1.3. Details of the supplier of the safety data sheet

Company	Harp International Limited
Address	Gellihirion Industrial Estate Pontypridd Rhondda Cynon Taff CF37 5SX UK
Web	www.harpintl.com
Telephone	+44 (0)1443 842 255
Fax	+44 (0)1443 841 805
Email	harp@harpintl.com
Email address of the competent person	safety@harpintl.com

#### 1.4. Emergency telephone number

Emergency telephone number	+44 (0) 1270 502891 24 Hours
----------------------------	---------------------------------

### SECTION 2: Hazards identification

#### 2.1. Classification of the substance or mixture

2.1.2. Classification - EC 1272/2008	Compressed gas: H280;
--------------------------------------	-----------------------

#### 2.2. Label elements

Hazard pictograms	
-------------------	---

## Harp® 134a

Revision 0

Revision date 2017-06-21

## 2.2. Label elements

Signal Word	Warning
Hazard Statement	Compressed gas: H280 - Contains gas under pressure; may explode if heated.
Precautionary Statement: Storage	P410+P403 - Protect from sunlight. Store in a well-ventilated place.

## 2.3. Other hazards

Other hazards	Asphyxiant in high concentrations. May cause cold burns/frostbite.
---------------	--

## SECTION 3: Composition/information on ingredients

## 3.1. Substances

## 67/548/EEC / 1999/45/EC

Chemical Name	Index No.	CAS No.	EC No.	REACH Registration Number	Conc. (%w/w)	Classification	M-factor.
Harp® 134a (1,1,1,2-Tetrafluoroethane (HFC 134a))		811-97-2	212-377-0	01-2119459374-33	90 - 100%		

## EC 1272/2008

Chemical Name	Index No.	CAS No.	EC No.	REACH Registration Number	Conc. (%w/w)	Classification	M-factor.
Harp® 134a (1,1,1,2-Tetrafluoroethane (HFC 134a))		811-97-2	212-377-0	01-2119459374-33	90 - 100%	Compressed gas: H280;	

## SECTION 4: First aid measures

## 4.1. Description of first aid measures

Inhalation	Move the exposed person to fresh air.
Eye contact	Rinse immediately with plenty of water.
Skin contact	Frostbite: treat as thermal burns.
Ingestion	Ingestion is not considered a potential route of exposure.

## 4.2. Most important symptoms and effects, both acute and delayed

Inhalation	Seek medical attention if irritation or symptoms persist.
Eye contact	Seek medical attention if irritation or symptoms persist.
Skin contact	Frostbite: treat as thermal burns.
Ingestion	Ingestion is not considered a potential route of exposure.

## 4.3. Indication of any immediate medical attention and special treatment needed

Inhalation	If you feel unwell, seek medical advice (show the label where possible).
Eye contact	Seek medical attention if irritation or symptoms persist.
Skin contact	Seek medical attention if irritation or symptoms persist.
Ingestion	Ingestion is not considered a potential route of exposure.

## SECTION 5: Firefighting measures

## 5.1. Extinguishing media

	Use extinguishing media appropriate to the surrounding fire conditions.
--	---

## 5.2. Special hazards arising from the substance or mixture

	This product is not flammable in air under ambient conditions of temperature and pressure. Certain mixtures of the product and air under pressure may be flammable. At high temperature :, Thermal decomposition giving toxic and corrosive products :, Gaseous hydrogen fluoride (HF)., Carbon oxides.
--	---

## 5.3. Advice for firefighters

	Wear self contained breathing apparatus and protective clothing. Cool containers / tanks with water spray. Ensure a system for the rapid emptying of containers. In case of fire nearby, remove
--	---

## Harp® 134a

Revision 0

Revision date 2017-06-21

## 5.3. Advice for firefighters

exposed containers.

**SECTION 6: Accidental release measures**

## 6.1. Personal precautions, protective equipment and emergency procedures

Ensure adequate ventilation of the working area. Avoid contact with skin and eyes. Evacuate personnel to a safe area. Wear self contained breathing apparatus and protective clothing. Vapours are heavier than air.

## 6.2. Environmental precautions

Do not release into the environment.

## 6.3. Methods and material for containment and cleaning up

Recovery: Allow to evaporate.  
Elimination: See chapter 13.

## 6.4. Reference to other sections

See section 8. EXPOSURE CONTROLS / PERSONAL PROTECTION for further information.  
See section 13. DISPOSAL CONSIDERATIONS for further information.

**SECTION 7: Handling and storage**

## 7.1. Precautions for safe handling

Ensure adequate ventilation of the working area. Avoid contact with eyes and skin. Adopt best Manual Handling considerations when handling, carrying and dispensing. Keep away from sources of ignition - No smoking. Do not eat, drink or smoke in areas where this product is used or stored. When using do not eat or drink. Wash hands after handling the product.

## 7.2. Conditions for safe storage, including any incompatibilities

Keep containers tightly closed. Keep in a cool, dry, well ventilated area. Store in correctly labelled containers. Keep away from sources of ignition - No smoking. Store out of direct sunlight. Storage temperature: <45°C.

## Suitable packaging

Stainless steel. Steel.

## 7.3. Specific end use(s)

See section 1.2. Relevant identified uses of the substance or mixture and uses advised against for further information.

**SECTION 8: Exposure controls/personal protection**

## 8.1. Control parameters

Occupational exposure controls.

## 8.1.1. Exposure Limit Values

Harp® 134a (1,1,1,2-Tetrafluoroethane (HFC 134a))	WEL 8-hr limit ppm: 1000	WEL 8-hr limit mg/m3: 4240
	WEL 15 min limit ppm: -	WEL 15 min limit mg/m3: -
	WEL 8-hr limit mg/m3 total - inhalable dust:	WEL 15 min limit mg/m3 total - inhalable dust:
	WEL 8-hr limit mg/m3 total - respirable dust:	WEL 15 min limit mg/m3 total - respirable dust:

## 8.2. Exposure controls

## Harp® 134a

Revision 0

Revision date 2017-06-21

## 8.2. Exposure controls

	
8.2.1. Appropriate engineering controls	Ensure adequate ventilation of the working area.
8.2.2. Individual protection measures	Wear protective clothing.
Eye / face protection	Approved safety goggles.
Skin protection - Handprotection	Wear suitable gloves.
Skin protection - Other	Wear suitable protective clothing.
Respiratory protection	Wear suitable respiratory equipment when necessary.
Occupational exposure controls	Keep away from food, drink and animal feedingstuffs.

## SECTION 9: Physical and chemical properties

## 9.1. Information on basic physical and chemical properties

Appearance	Gas
Colour	Colourless
Odour	Slight
Odour threshold	No data available
Freezing Point	No data available
Evaporation rate	No data available
Water solubility	No data available
Fat Solubility	No data available
Soluble in	No data available
Partition coefficient (n-octanol/water)	No data available
Partition coefficient	No data available
Autoignition temperature	> 743 °C
Decomposition temperature	> 370 °C
Vapour pressure	= 0.574 MPa
Vapour density	= 4.24 kg/m <sup>3</sup>
Relative density	= 1.21 (H <sub>2</sub> O = 1 @ 20 °C)
Initial boiling point	- 26 °C
Melting point	- 108 °C
Flash point	Not applicable.
pH	Not applicable.
Flammability (solid, gas)	Not applicable.
Viscosity	Not applicable.
Explosive properties	Not applicable.
Oxidising properties	Not applicable.
Solubility	No data available

## 9.2. Other information



## Harp® 134a

Revision 0

Revision date 2017-06-21

## 9.2. Other information

VOC (Volatile organic compounds)	Not relevant
Conductivity	No data available
Surface tension	No data available
Gas group	No data available
Benzene Content	No data available
Lead content	No data available

## SECTION 10: Stability and reactivity

## 10.1. Reactivity

	Stable under normal conditions. The gaseous product in presence of air can form, under certain conditions of temperature and pressure, a flammable mixture.
--	---

## 10.2. Chemical stability

	Stable under normal conditions. The gaseous product in presence of air can form, under certain conditions of temperature and pressure, a flammable mixture.
--	---

## 10.3. Possibility of hazardous reactions

	No data is available on this product.
--	---------------------------------------

## 10.4. Conditions to avoid

	Keep away from heat and sources of ignition. Avoid contact with flames and red hot metallic surfaces.
--	---

## 10.5. Incompatible materials

	Alkaline hydroxides. Alkaline earth metals. Strong oxidising agents. Finely divided metals.
--	---

## 10.6. Hazardous decomposition products

	At high temperature ; Thermal decomposition giving toxic and corrosive products ; Gaseous hydrogen fluoride (HF)., Carbon oxides. Decomposition temperature: >370°C.
--	--

## SECTION 11: Toxicological information

## 11.1. Information on toxicological effects

Acute toxicity	Slightly harmful by inhalation. As with other volatile aliphatic halogenated compounds, through vapour accumulation and/or inhalation of large quantities, the product can cause ; Loss of consciousness and cardiac disorders aggravated by stress and lack of oxygen, risk of mortality.
Skin corrosion/irritation	Ejection of liquefied gas : frostbite possible.
Serious eye damage/irritation	Ejection of liquefied gas : frostbite possible.
Respiratory or skin sensitisation	No data available.
Germ cell mutagenicity	No data available.
Carcinogenicity	No data available.
Reproductive toxicity	No data available.
STOT-single exposure	No data available.
STOT-repeated exposure	No data available.
Aspiration hazard	No data available.
Repeated or prolonged exposure	No data available.

## 11.1.4. Toxicological Information

	No data available
--	-------------------

## SECTION 12: Ecological information

## Harp® 134a

Revision 0  
Revision date 2017-06-21

## 12.1. Toxicity

No data available

## 12.2. Persistence and degradability

Not readily biodegradable.

## 12.3. Bioaccumulative potential

Does not bioaccumulate.

## Partition coefficient

Harp® 134a No data available

## 12.4. Mobility in soil

No data is available on this product.

## 12.5. Results of PBT and vPvB assessment

This substance is not considered to be persistent, bioaccumulating, toxic (PBT), nor very persistent, very bioaccumulating (vPvB).

## 12.6. Other adverse effects

Global warming potential (GWP): Global warming potential with respect to CO<sub>2</sub> = 1430 (IPCC Assessment Report 4).  
Ozone depletion potential: Ozone depletion potential; ODP; (R-11 = 1), Value:.

## SECTION 13: Disposal considerations

## 13.1. Waste treatment methods

Dispose of in compliance with all local and national regulations.

## Disposal methods

Contact a licensed waste disposal company.

## SECTION 14: Transport information

## Hazard pictograms



## 14.1. UN number

UN3159

## 14.2. UN proper shipping name

1,1,1,2-TETRAFLUOROETHANE

## 14.3. Transport hazard class(es)

ADR/RID	2
Subsidiary risk	-
IMDG	2.2
Subsidiary risk	-
IATA	2.2
Subsidiary risk	-

## 14.4. Packing group

Packing group -

## Harp® 134a

Revision 0

Revision date 2017-06-21

## 14.5. Environmental hazards

Environmental hazards	No
Marine pollutant	No

## 14.6. Special precautions for user

	No data is available on this product.
--	---------------------------------------

## 14.7. Transport in bulk according to Annex II of MARPOL 73/78 and the IBC Code

	No data is available on this product.
--	---------------------------------------

## ADR/RID

Hazard ID	20
Tunnel Category	(C/E)

## IMDG

EmS Code	F-C S-V
----------	---------

## IATA

Packing Instruction (Cargo)	200
Maximum quantity	150 kg
Packing Instruction (Passenger)	200
Maximum quantity	75 kg

## SECTION 15: Regulatory information

## 15.1. Safety, health and environmental regulations/legislation specific for the substance or mixture

Regulations	REGULATION (EC) No 1907/2006 OF THE EUROPEAN PARLIAMENT AND OF THE COUNCIL of 18 December 2006 concerning the Registration, Evaluation, Authorisation and Restriction of Chemicals (REACH), establishing a European Chemicals Agency, amending Directive 1999/45/EC and repealing Council Regulation (EEC) No 793/93 and Commission Regulation (EC) No 1488/94 as well as Council Directive 76/769/EEC and Commission Directives 91/155/EEC, 93/67/EEC, 93/105/EC and 2000/21/EC.
-------------	---

## 15.2. Chemical safety assessment

	No data is available on this product.
--	---------------------------------------

## SECTION 16: Other information

## Other information

Text of Hazard Statements in Section 3	Compressed gas: H280 - Contains gas under pressure; may explode if heated.
--	--

## Further information

	The information supplied in this Safety Data Sheet is designed only as guidance for the safe use, storage and handling of the product. This information is correct to the best of our knowledge and belief at the date of publication however no guarantee is made to its accuracy. This information relates only to the specific material designated and may not be valid for such material used in combination with any other materials or in any other process.
--	--

# SAFETY DATA SHEET

## HEXID A4 HEAT TRANSFER FLUID

Conforming to Directive 1907/2006/EC

### SECTION 1: IDENTIFICATION OF THE SUBSTANCE/MIXTURE AND OF THE COMPANY/UNDERTAKING

<b>1.1. Product Name</b>	Hexid A4
<b>1.2. Supplier</b>	Applied Thermal Control Limited 39 Hayhill Industrial Estate, Barrow upon Soar, Leicestershire, LE12 8LD. United Kingdom. www.app-therm.com
<b>1.3. Telephone Number</b>	+44(0)1530 839998
<b>1.4. Email</b>	<a href="mailto:sales@app-therm.com">sales@app-therm.com</a>
<b>1.5. Emergency Telephone Number</b>	+44(0)1530 839998
<b>1.6. Intended/Recommended Use</b>	Heat Transfer Fluid

### SECTION 2: HAZARDS IDENTIFICATION

- 2.1. Classification of the substance or mixture**  
The product is not classified as dangerous according to Regulation (EC) No. 1272/2008.  
This mixture is not classified as dangerous according to Directive 1999/45/EC.

### SECTION 3: COMPOSITION/INFORMATION ON INGREDIENTS

- 3.1. Chemical Nature** Water (CAS 7732-18-5), not classified.  
Propylene glycol (CAS 57-55-6) (REACH 01-2119456809-23)  
(EINECS 200-338-0) not classified.  
Fluorescein (trace) and biocide (trace) not classified.
- 3.2. Food Grade**

### SECTION 4: FIRST AID MEASURES

- General advise** No special precautions required. Treat symptomatically.
- 4.1. Eye Contact** Rinse thoroughly with plenty of water, also under the eyelids. Remove contact lenses after a few minutes and continue rinsing. If symptoms persist, call a physician.
- 4.2. Skin Contact** Wash off immediately with plenty of water. If skin irritation persists, call a physician.
- 4.3. Inhalation** Remove to fresh air. If symptoms persist, call a physician.
- 4.4. Ingestion** Rinse mouth with water. Never give anything by mouth to an unconscious person. If symptoms persist, call a physician.

### SECTION 5: FIREFIGHTING MEASURES

- 5.1. Extinguishing media**  
Use extinguishing measures that are appropriate to local circumstances and the surrounding environment. Water spray, foam, dry powder or CO<sub>2</sub>. Alcohol-resistant foam
- 5.2. Unsuitable extinguishing Media**  
High volume water jet. Do not use a solid water stream as it may scatter and spread fire.
- 5.3. Specific hazards during firefighting**  
In fire conditions, toxic decomposition products may be formed (see also section 10). In combustion, emits fumes, smoke, carbon dioxide (CO<sub>2</sub>) and carbon monoxide (CO). Heating will cause a pressure rise - with severe risk of bursting and explosion, Violent steam generation or eruption may occur upon application of direct water to hot liquids.
- 5.4. Advice for firefighters**  
In the event of fire, wear self-contained breathing apparatus. Wear personal protective equipment. Promptly isolate the scene by removing all persons from the vicinity of the incident if there is a fire. Keep containers cool by spraying with water if exposed to fire. Collect contaminated fire extinguishing water separately. This must not be discharged into drains. Burning fluids may be extinguished by dilution with water

# SAFETY DATA SHEET

## HEXID A4 HEAT TRANSFER FLUID

Conforming to Directive 1907/2006/EC

### SECTION 6: ACCIDENTAL RELEASE MEASURES

- 6.1. Personal precautions**  
Use personal protective equipment. Avoid contact with skin and eyes. Keep unnecessary and unprotected personnel from entering the area.
- 6.2. Precaution to protect the environment**  
Do not flush into surface water or sanitary sewer system. Avoid subsoil penetration.
- 6.3. Clean-up procedures**  
Contain the spillage, soak up with non-combustible absorbent material, (e.g. sand, earth, diatomaceous earth, vermiculite) and transfer to a container for disposal according to local / national regulations (see section 13). Keep in suitable, closed containers for disposal. Dike the area of spill to prevent spreading and pump liquid to salvage tank. Treat recovered material as described in section 13 Disposal considerations.

### SECTION 7: HANDLING AND STORAGE

- 7.1. Precautions for safe handling**  
Keep container tightly closed. Handle in accordance with good industrial hygiene and safety practice. Spills of these organic materials on hot fibrous insulations may lead to lowering of the auto-ignition temperatures possibly resulting in spontaneous combustion.
- 7.2. Conditions for safe storage**  
Keep only in the original container.

### SECTION 8: EXPOSURE CONTROLS/PERSONAL PROTECTION

- 8.1. Control parameters**  
Component: Propane-1,2-diol CAS-No. 57-55-6  
Other Occupational Exposure Limit Values EH40 WEL, Time Weighted Average (TWA):, Total vapour and particulates.150 ppm, 474 mg/m<sup>3</sup>  
EH40 WEL, Time Weighted Average (TWA):, Particulate.10 mg/m<sup>3</sup>  
ELV (IE), Time Weighted Average (TWA):, Total vapour and particulates.150 ppm, 470 mg/m<sup>3</sup>  
ELV (IE), Time Weighted Average (TWA):, Particulate.10 mg/m<sup>3</sup>
- 8.2. Exposure controls/Appropriate engineering controls**  
Local exhaust. If this product contains ingredients with exposure limits, use process enclosures, local exhaust ventilation or other engineering controls to keep worker exposure below any recommended or statutory limits.
- Personal protective equipment**  
Respiratory protection Suitable respiratory protective device Combination filter: A-P2  
Filter Type Combined particulates and organic vapour type  
Hand protection Category short time exposure Break through time > 10 min  
Protective index Class 1 When prolonged exposure is expected: Break through time > 120 min  
Protective index Class 4 Observe the information of the glove manufacturers on permeability.  
Protective gloves should be chosen according to Workplace Safety Assessment.  
Gloves recommended according to EN 374 (protection against chemicals).  
Material Chemical resistant gloves made of butyl rubber or nitrile rubber category III according to EN 374.

### SECTION 9: PHYSICAL AND CHEMICAL PROPERTIES

9.1	Appearance at 20°C	Fluorescent green clear liquid
9.2	Odour	Almost odourless
9.3	Flash point	Boils without flashing
9.4	Ignition temperature	Not Available
9.5	Flammability Limit	Not Available
9.6	Oxidizing Properties	Not Available
9.7	Auto flammability	450°C
9.8	Density at 25°C	~1.036g/cm <sup>3</sup>
9.9	pH (as is)	7
9.10	Boiling point	102°C
9.7	Auto flammability	450°C
9.8	Solubility in water	Miscible
9.9	Freezing point	-21°C
9.10	Specific Heat Capacity	3.78kJ/kg °K
9.11	Viscosity, Kinetic, at 25°C	3.51mPa.s

# SAFETY DATA SHEET

## HEXID A4 HEAT TRANSFER FLUID

Conforming to Directive 1907/2006/EC

---

### SECTION 10: STABILITY AND REACTIVITY

---

**10.1. Reactivity**

Stable under recommended storage conditions. No dangerous reaction known under conditions of normal use.

**10.2. Chemical stability**

No decomposition if stored and applied as directed. Stable under recommended storage conditions. Hygroscopic.

**10.3. Hazardous reactions**

Hazardous polymerisation does not occur.

**10.4. Conditions to avoid**

Generation of gas from decomposition causes pressure in closed systems. Keep away from direct sunlight. Avoid high temperatures. Avoid temperatures exceeding the decomposition temperature. Avoid UV light.

**10.5. Materials to avoid**

Strong acids, Strong bases, Strong oxidizing agents.

**10.6. Hazardous decomposition products**

Aldehydes, Alcohols, Ether, Organic acids.

---

### SECTION 11: TOXICOLOGICAL INFORMATION

---

**11.1. Toxicity Oral**

LD50 : > 20000 mg/kg (rat) This product can present a small hazard if large quantities are swallowed.

**11.2. Inhalation**

LC50 : 6.15 mg/l (rat; 4 h; vapour) At ambient temperature the exposure to vapours is minimal due to a low volatility rate. Inhalation may cause irritation to the nose, throat, upper respiratory tract and lungs. No deaths occurred

**11.3. Dermal**

LD50 : > 20000 mg/kg (rabbit) Prolonged skin contact is unlikely to result in absorption of harmful amounts. Skin irritation by prolonged exposure is unlikely. Repeated contact may cause flaking and softening of skin.

**11.4. Eyes**

Slight irritation is possible. Direct contact with eyes may cause temporary irritation. Corneal injury is unlikely.

**11.5. Sensitisation**

Patch test on human volunteers did not demonstrate sensitisation properties.

**11.6. CMR Carcinogenicity**

Animal testing did not show any carcinogenic effects. Information given is based on data obtained from similar substances.

**11.7. Mutagenicity**

No data available.

**11.8. Reproductive toxicity**

No data available.

**11.9. Specific Target Organ Toxicity**

Single exposure no data available. Repeated exposure no data available.

**11.10. Other toxic properties**

Repeated dose toxicity. In rare cases, repeated excessive exposure to propylene glycol may cause central nervous system effects. Aspiration hazard Due to its physical properties, the substance does probably not pose any aspiration hazard.

**11.11. Other relevant toxicity information**

Handle in accordance with good industrial hygiene and safety practice.

**11.12. Experience with human exposure**

Health injuries are not known or expected under normal use.

# SAFETY DATA SHEET

## HEXID A4 HEAT TRANSFER FLUID

Conforming to Directive 1907/2006/EC

### SECTION 12: ECOLOGICAL INFORMATION

#### 12.1. Acute toxicity

Fish - LC50 : 40613 mg/l (Oncorhynchus mykiss; 96 h) (static test)

Daphnia and other aquatic invertebrates - LC50 : 18340 mg/l (Ceriodaphnia Dubia (water flea); 48 h) (static test)

Algae - ErC50 : 19000 mg/l (Pseudokirchneriella subcapitata (green algae); 96 h) (Growth inhibition)

Bacteria - NOEC : > 20000 mg/l (Pseudomonas putida; 18 h) Chronic toxicity

Aquatic invertebrates - NOEC : 13020 mg/l (Ceriodaphnia Dubia (water flea); 7 d) (semi-static test)

#### 12.2. Persistence and degradability

Biodegradability 81 % (anaerobic; Exposure Time: 28 d)(OECD 301 F)

Readily biodegradable 96 % (anaerobic; Exposure Time: 64 d)(OECD 306.)

#### 12.3. Bioaccumulative potential

BCF - 0.09 estimated Low bioaccumulative potential

#### 12.4. Mobility

Estimated Koc < 1, indicating very high soil mobility.

#### 12.5. PBT and vPvB assessment

Not a PBT or vPvB substance or mixture

#### 12.6. Other adverse effects

Do not flush into surface water or sanitary sewer system. Avoid subsoil penetration. This substance is not in Annex I of Regulation (EC) 2037/2000 on substances that deplete the ozone layer.

### SECTION 13: DISPOSAL CONSIDERATION

#### 13.1. Waste treatment methods

Disposal together with normal waste is not allowed. Special disposal required according to local regulations. Do not let product enter drains. Contact waste disposal services.

#### 13.2. Contaminated packaging

Empty contaminated packaging thoroughly. They can be recycled after thorough and proper cleaning. Packaging that cannot be cleaned are to be disposed of in the same manner as the product.

#### 13.3. European Waste Catalogue Number

No waste code according to the European Waste Catalogue can be assigned for this product, as the intended use dictates the assignment. The waste code is established in consultation with the regional waste disposer.

### SECTION 14: TRANSPORT INFORMATION

Not dangerous goods for ADR, RID, IMDG and IATA.

#### 14.1. EEC Regulations

**UNNO** None **Class** None **Packing Group** None

Road & Rail Transport (ADR & RID) None **IMDG** Not Applicable **ICOA** None

### SECTION 15: REGULATORY INFORMATION

**15.1** Classification Not classified as hazardous to users.

**15.2** CAS No. 57556

**15.3** Risk or Safety phrases None

**15.4** Labelling None

### SECTION 16: OTHER INFORMATION

Key literature references and sources for data taken from supplier information and data from the "Database of registered substances" of the European Chemicals Agency (ECHA) were used to create this safety data sheet. Other information - The information provided in this Safety Data Sheet is correct to our knowledge at the date of its revision. The information given only describes the products with regard to safety arrangements and is not to be considered as a warranty or quality specification and does not constitute a legal relationship.

The information contained in this Safety Data Sheet relates only to the specific material designated and may not be valid for such material used in combination with any other material or in any process, unless specified in the text.